

DLP® Projector

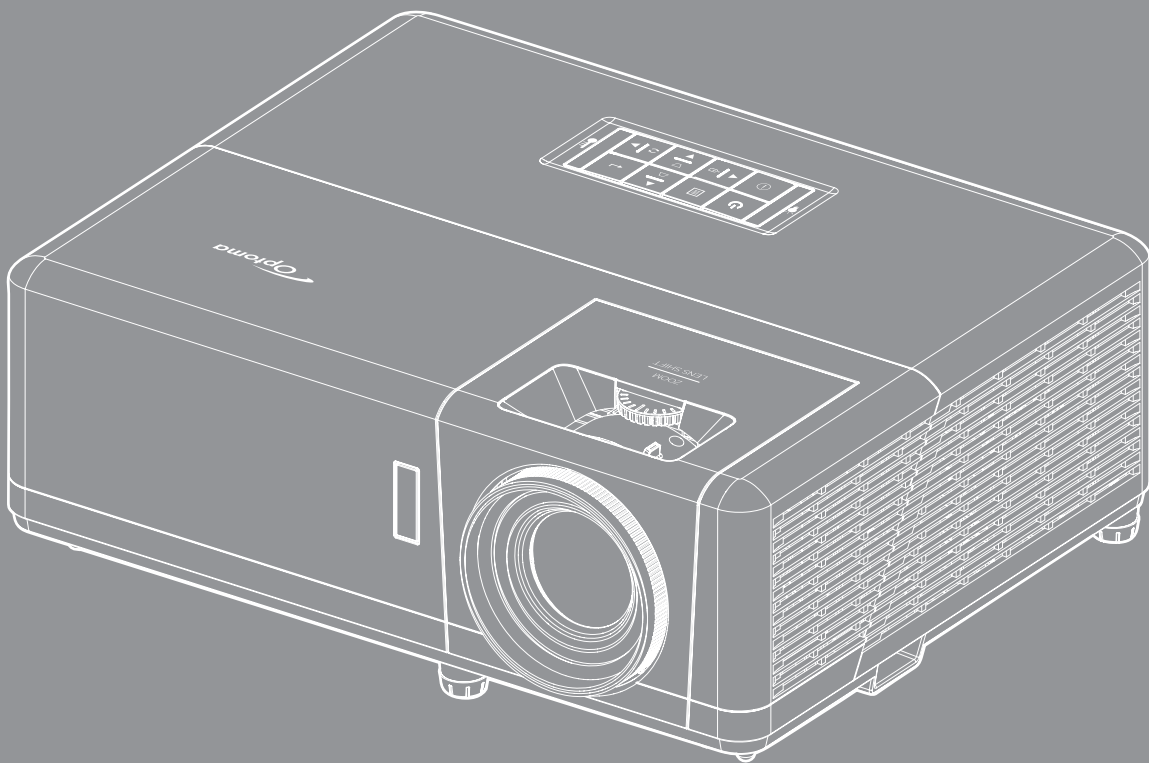

TABLE OF CONTENTS



SAFETY	4
<i>Important Safety Instruction</i>	4
<i>Laser Radiation Safety Information</i>	5
<i>Cleaning the Lens</i>	6
<i>3D Safety Information</i>	6
<i>Copyright</i>	7
<i>Disclaimer</i>	7
<i>Trademark Recognition</i>	7
<i>FCC</i>	7
<i>Declaration of Conformity for EU countries</i>	8
<i>WEEE</i>	8
INTRODUCTION	9
<i>Package Overview</i>	9
<i>Standard accessories</i>	9
<i>Product Overview</i>	10
<i>Connections</i>	11
<i>Keypad</i>	12
<i>Remote control</i>	13
SETUP AND INSTALLATION	14
<i>Installing the projector</i>	14
<i>Connecting sources to the projector</i>	16
<i>Adjusting the projector image</i>	17
<i>Remote setup</i>	18
<i>Initial setup</i>	20
USING THE PROJECTOR	22
<i>Powering on / off the projector</i>	22
<i>Selecting an input source</i>	23
<i>Home screen overview</i>	24
<i>System date and time</i>	24
<i>Projector settings menu (OSD)</i>	25
<i>OSD Menu tree</i>	26
<i>Display menu</i>	33
<i>Image settings menu</i>	33
<i>Enhanced gaming menu</i>	36
<i>3D menu</i>	37
<i>Aspect ratio menu</i>	38
<i>Edge mask menu</i>	39
<i>Digital zoom menu</i>	39
<i>Image shift menu</i>	39
<i>Geometric correction menu</i>	39

<i>Audio menu</i>	40
<i>Mute menu</i>	40
<i>Volume menu</i>	40
<i>Audio input menu</i>	40
<i>Setup menu</i>	41
<i>Projection menu</i>	41
<i>Power settings menu</i>	41
<i>Security menu</i>	42
<i>HDMI link settings menu</i>	42
<i>Test pattern menu</i>	43
<i>Projector ID menu</i>	43
<i>12V trigger menu</i>	43
<i>Options menu</i>	43
<i>Reset OSD menu</i>	44
<i>Info menu</i>	45
<i>System settings menu</i>	46
<i>Selecting an input source</i>	60
<i>Selecting an app</i>	61
<i>Supported multimedia formats</i>	65
<i>Viewing the status bar</i>	66

ADDITIONAL INFORMATION..... 67

<i>Compatible resolutions</i>	67
<i>Image size and projection distance</i>	73
<i>Projector dimensions and ceiling mount installation</i>	74
<i>IR remote codes</i>	75
<i>Troubleshooting</i>	76
<i>Warning indicators</i>	78
<i>Specifications</i>	79
<i>Optoma global offices</i>	80

SAFETY

	The lightning flash with arrow head within an equilateral triangle is intended to alert the user to the presence of uninsulated "dangerous voltage" within the product's enclosure that may be of sufficient magnitude to constitute a risk of electric shock to persons.
	The exclamation point within an equilateral triangle is intended to alert the user to the presence of important operating and maintenance (servicing) instructions in the literature accompanying the appliance.

Please follow all warnings, precautions and maintenance as recommended in this user's guide.

Important Safety Instruction

- Do not block any ventilation openings. To ensure reliable operation of the projector and to protect from over heating, it is recommended to install the projector in a location that does not block ventilation. As an example, do not place the projector on a crowded coffee table, sofa, bed, etc. Do not put the projector in an enclosure such as a book case or a cabinet that restricts air flow.
- To reduce the risk of fire and/or electric shock, do not expose the projector to rain or moisture. Do not install near heat sources such as radiators, heaters, stoves or any other apparatus such as amplifiers that emits heat.
- Do not let objects or liquids enter the projector. They may touch dangerous voltage points and short out parts that could result in fire or electric shock.
- Do not use under the following conditions:
 - In extremely hot, cold or humid environments.
 - (i) Ensure that the ambient room temperature is within 0°C ~ 40°C
 - (ii) Relative humidity is 10% ~ 85%
 - In areas susceptible to excessive dust and dirt.
 - Near any appliance generating a strong magnetic field.
 - In direct sunlight.
- Do not use the unit if it has been physically damaged or abused. Physical damage/abuse would be (but not limited to):
 - Unit has been dropped.
 - Power supply cord or plug has been damaged.
 - Liquid has been spilled on to the projector.
 - Projector has been exposed to rain or moisture.
 - Something has fallen in the projector or something is loose inside.
- Do not place the projector on an unstable surface. The projector may fall over resulting in injury or the projector may become damaged.
- Do not block the light coming out of the projector lens when in operation. The light will heat the object and may melt, cause burns or start a fire.
- Please do not open or disassemble the projector as this may cause electric shock.
- Do not attempt to service the unit yourself. Opening or removing covers may expose you to dangerous voltages or other hazards. Please call Optoma before you send the unit for repair.
- See projector enclosure for safety related markings.
- The unit should only be repaired by authorized service personnel.
- Only use attachments/accessories specified by the manufacturer.
- Do not look into straight into the projector lens during operation. The bright light may harm your eyes.
- This projector will detect the life of the light source itself.

- When switching the projector off, please ensure the cooling cycle has been completed before disconnecting power. Allow 90 seconds for the projector to cool down.
- Turn off and unplug the power plug from the AC outlet before cleaning the product.
- Use a soft dry cloth with mild detergent to clean the display housing. Do not use abrasive cleaners, waxes or solvents to clean the unit.
- Disconnect the power plug from AC outlet if the product is not being used for a long period of time.
- Do not setup the projector in places where it might be subjected to vibration or shock.
- Do not touch the lens with bare hands.
- Remove battery/batteries from remote control before storage. If the battery/batteries are left in the remote for long periods, they may leak.
- Do not use or store the projector in places where smoke from oil or cigarettes may be present, as it can adversely affect the quality of the projector performance.
- Please follow the correct projector orientation installation as non standard installation may affect the projector performance.
- Use a power strip and or surge protector. As power outages and brown-outs can KILL devices.

Laser Radiation Safety Information

- This product is classified as CLASS 1 LASER PRODUCT - RISK GROUP 2 of IEC60825-1 : 2014 and also complies with 21 CFR 1040.10 and 1040.11 as a Risk Group 2, LIP (Laser Illuminated Projector) as defined in IEC 62471-5:Ed. 1.0. For more information see Laser Notice No. 57, dated May 8, 2019.

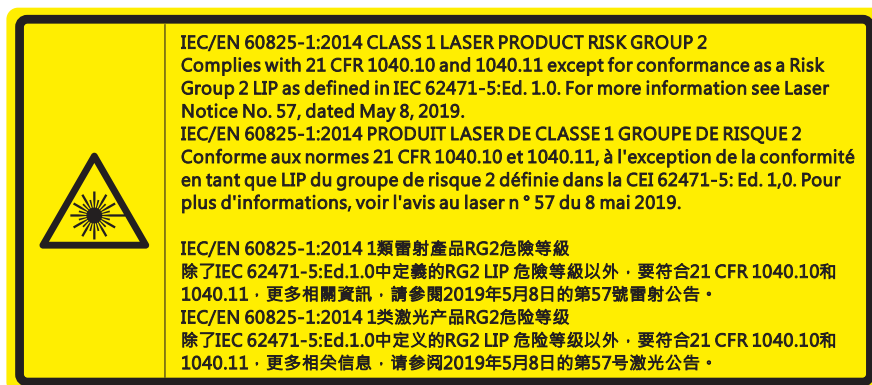

- As with any bright source, do not stare into the direct beam, RG2 IEC 62471-5:2015.
- This projector is class 1 laser product of IEC/EN 60825-1:2014 and risk group 2 with the requirements of IEC 62471-5:2015.
- Additional instructions to supervise children, no staring, and not use optical aids.
- Notice is given to supervise children and to never allow them to stare into the projector beam at any distance from the projector.
- Notice is given to use caution when using the remote control for starting the projector while in front of the projection lens.
- Notice is given to the user to avoid the use of optical aids such as binoculars or telescopes inside the beam.

- When turning on the projector, make sure no one within projection range is looking at the lens.
- Keep any items (magnifying glass etc.) out of the light path of the projector. The light path being projected from the lens is extensive, therefore any kind of abnormal objects that can redirect light coming out of the lens, can cause an unpredictable outcome such as a fire or injury to the eyes.
- Any operation or adjustment not specifically instructed by the user's guide creates the risk of hazardous laser radiation exposure.
- Do not open or disassemble the projector as this may cause damage by the exposure of laser radiation.
- Do not stare into beam when the projector is on. The bright light may result in permanent eye damage.

Not following the control, adjustment or operation procedure may cause damage by the exposure of laser radiation.

Cleaning the Lens

- Before cleaning the lens, be sure to turn off the projector and unplug the power cord to allow it to completely cool down.
- Use a compressed air tank to remove the dust.
- Use a special cloth for cleaning lens and gently wipe the lens. Do not touch the lens with your fingers.
- Do not use alkaline/acid detergents or volatile solvents such as alcohol for cleaning lens. If the lens is damaged due to the cleaning process, it is not covered by the warranty.



Warning: Do not use a spray containing flammable gases to remove dust or dirt from the lens. This may cause a fire due to excessive heat inside the projector.



Warning: Do not clean the lens if the projector is warming up as this may cause the lens' surface film to peel off.



Warning: Do not wipe or tap the lens with a hard object.

3D Safety Information

Please follow all warnings and precautions as recommended before you or your child use the 3D function.

Warning

Children and teenagers may be more susceptible to health issues associated with viewing in 3D and should be closely supervised when viewing these images.

Photosensitive Seizure Warning and Other Health Risks

- Some viewers may experience an epileptic seizure or stroke when exposed to certain flashing images or lights contained in certain Projector pictures or video games. If you suffer from, or have a family history of epilepsy or strokes, please consult with a medical specialist before using the 3D function.
- Even those without a personal or family history of epilepsy or stroke may have an undiagnosed condition that can cause photosensitive epileptic seizures.
- Pregnant women, the elderly, sufferers of serious medical conditions, those who are sleep deprived or under the influence of alcohol should avoid utilizing the unit's 3D functionality.
- If you experience any of the following symptoms, stop viewing 3D pictures immediately and consult a medical specialist: (1) altered vision; (2) light-headedness; (3) dizziness; (4) involuntary movements such as eye or muscle twitching; (5) confusion; (6) nausea; (7) loss of awareness; (8) convulsions; (9) cramps; and/ or (10) disorientation. Children and teenagers may be more likely than adults to experience these symptoms. Parents should monitor their children and ask whether they are experiencing these symptoms.
- Watching 3D projection may also cause motion sickness, perceptual after effects, disorientation, eye strain and decreased postural stability. It is recommended that users take frequent breaks to lessen the potential of these effects. If your eyes show signs of fatigue or dryness or if you have any of the

above symptoms, immediately discontinue use of this device and do not resume using it for at least thirty minutes after the symptoms have subsided.

- Watching 3D projection while sitting too close to the screen for an extended period of time may damage your eyesight. The ideal viewing distance should be at least three times the screen height. It is recommended that the viewer's eyes are level with the screen.
- Watching 3D projection while wearing 3D glasses for an extended period of time may cause a headache or fatigue. If you experience a headache, fatigue or dizziness, stop viewing the 3D projection and rest.
- Do not use the 3D glasses for any other purpose than for watching 3D projection.
- Wearing the 3D glasses for any other purpose (as general spectacles, sunglasses, protective goggles, etc.) may be physically harmful to you and may weaken your eyesight.
- Viewing in 3D projection may cause disorientation for some viewers. Accordingly, DO NOT place your 3D PROJECTOR near open stairwells, cables, balconies, or other objects that can be tripped over, run into, knocked down, broken or fallen over.

Copyright

This publication, including all photographs, illustrations and software, is protected under international copyright laws, with all rights reserved. Neither this manual, nor any of the material contained herein, may be reproduced without written consent of the author.

© Copyright 2022

Disclaimer

The information in this document is subject to change without notice. The manufacturer makes no representations or warranties with respect to the contents hereof and specifically disclaims any implied warranties of merchantability or fitness for any particular purpose. The manufacturer reserves the right to revise this publication and to make changes from time to time in the content hereof without obligation of the manufacturer to notify any person of such revision or changes.

Trademark Recognition

Kensington is a U.S. registered trademark of ACCO Brand Corporation with issued registrations and pending applications in other countries throughout the world.

HDMI, the HDMI Logo, and High-Definition Multimedia Interface are trademarks or registered trademarks of HDMI Licensing LLC in the United States and other countries.

DLP®, DLP Link and the DLP logo are registered trademarks of Texas Instruments and BrilliantColor™ is a trademark of Texas Instruments.

All other product names used in this manual are the properties of their respective owners and are Acknowledged.

FCC

This device has been tested and found to comply with the limits for a Class B digital device pursuant to Part 15 of the FCC rules. These limits are designed to provide reasonable protection against harmful interference in a residential installation. This device generates, uses and can radiate radio frequency energy and, if not installed and used in accordance with the instructions, may cause harmful interference to radio communications.

However, there is no guarantee that interference will not occur in a particular installation. If this device does cause harmful interference to radio or television reception, which can be determined by turning the device off and on is encouraged to try to correct the interference by one or more of the following measures:

- Reorient or relocate the receiving antenna.
- Increase the separation between the device and receiver.
- Connect the device into an outlet on a circuit different from that to which the receiver is connected.
- Consult the dealer or an experienced radio/television technician for help.

Notice: Shielded cables

All connections to other computing devices must be made using shielded cables to maintain compliance with FCC regulations.

Caution

Changes or modifications not expressly approved by the manufacturer could void the user's authority, which is granted by the Federal Communications Commission, to operate this projector.

Operation Conditions

This device complies with Part 15 of the FCC Rules. Operation is subject to the following two conditions:

1. This device may not cause harmful interference and
2. This device must accept any interference received, including interference that may cause undesired operation.

Notice: Canadian users

This Class B digital apparatus complies with Canadian ICES-003.

Remarque à l'intention des utilisateurs canadiens

Cet appareil numérique de la classe B est conforme à la norme NMB-003 du Canada.

Declaration of Conformity for EU countries

- EMC Directive 2014/30/EU (including amendments)
- Low Voltage Directive 2014/35/EU
- RED 2014/53/EU (if product has RF function)

WEEE



Disposal instructions

Do not throw this electronic device into the trash when discarding. To minimize pollution and ensure utmost protection of the global environment, please recycle it.

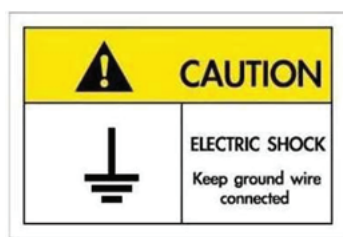

To avoid electric shock, the unit and its peripherals must be properly grounded (earthed).

INTRODUCTION

Thank you for purchasing an Optoma laser projector. For full list of features please visit the product page on our website, where you will also find additional information and documentation such as FAQs.

Package Overview

Carefully unpack and verify that you have the items listed below under standard accessories. Some of the items under optional accessories may not be available depending on the model, specification and your region of purchase. Please check with your place of purchase. Some accessories may vary from region to region.

The warranty card is only supplied in some specific regions. Please consult your dealer for detailed information.

Standard accessories

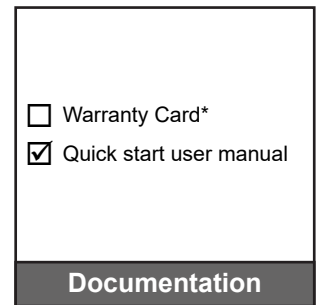
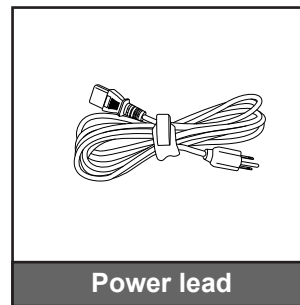
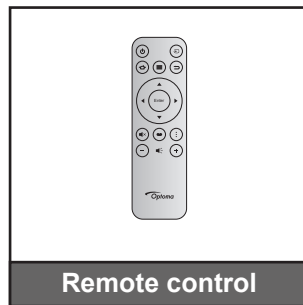
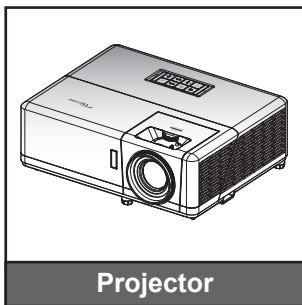

Note:

- *The remote control is shipped with batteries.*
- ** For warranty Information, please visit www.optoma.com.*
- *Accessories vary depending on model, specification and region. Some optional accessories may be available to purchase in select regions. Please visit our website to see more details regarding the accessories included.*

INTRODUCTION

Product Overview

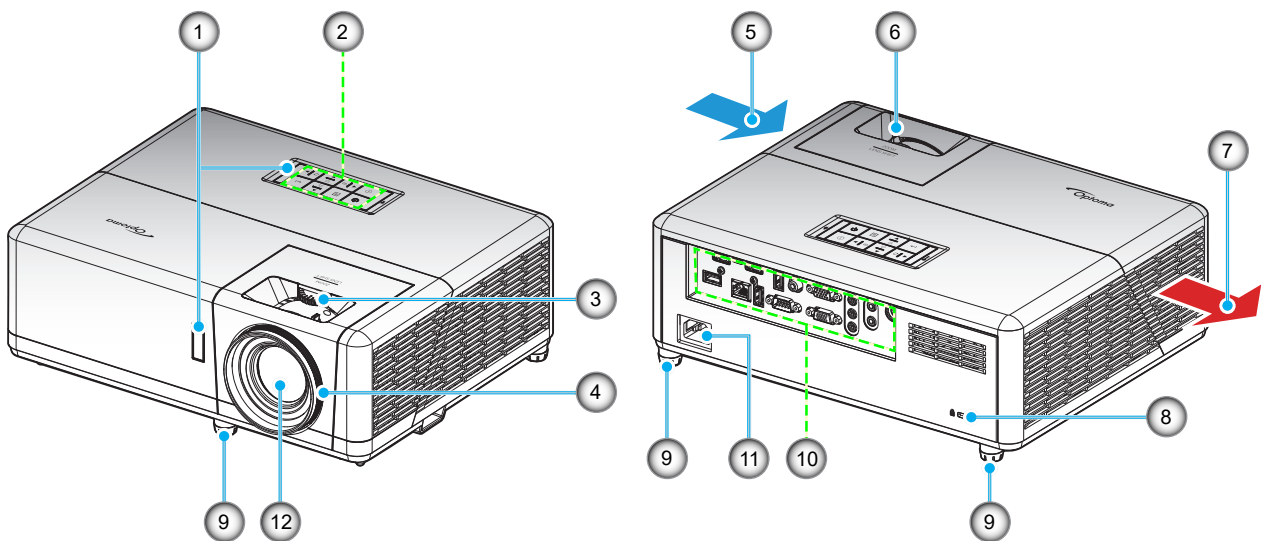

Note:

- Do not block projector intake and exhaust vents.
- When operating the projector in an enclosed space, allow at least 30 cm clearance around the intake and exhaust vents.

No	Item	No	Item
1.	IR Receivers	7.	Ventilation (outlet)
2.	Keypad	8.	Kensington™ Lock Port
3.	Lens Shift Dial	9.	Tilt-Adjustment Feet
4.	Focus Ring	10.	Input / Output
5.	Ventilation (inlet)	11.	Power Socket
6.	Zoom Lever	12.	Lens

INTRODUCTION

Connections

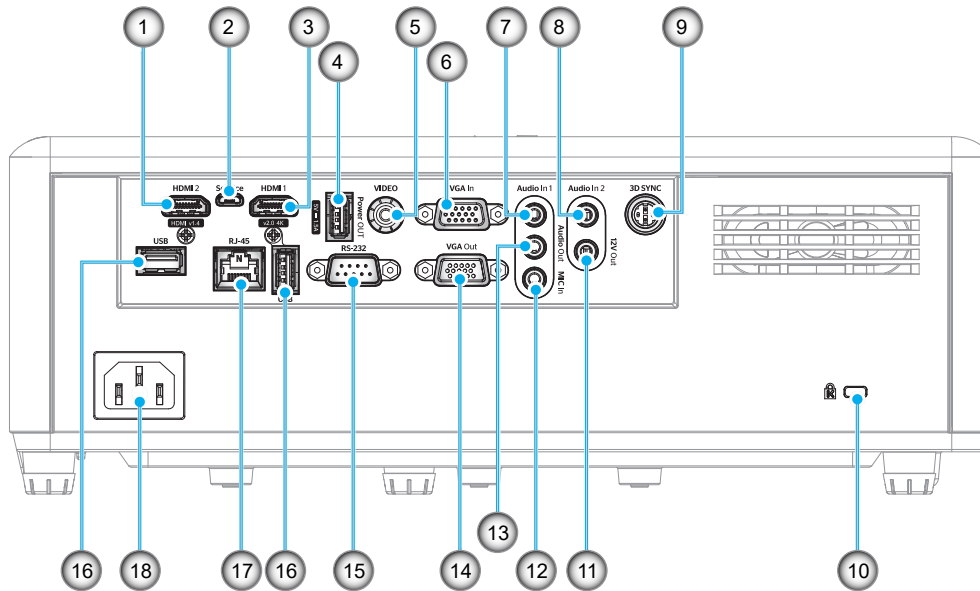

No	Item	No	Item
1.	HDMI 2 Connector	10.	Kensington™ Lock Port
2.	Micro USB Connector	11.	12V Out Connector
3.	HDMI 1 Connector	12.	MIC In Connector
4.	USB Power Out (5V---1.5A) Connector	13.	Audio Out Connector
5.	Video Connector	14.	VGA Out Connector
6.	VGA In Connector	15.	RS-232 Connector
7.	Audio In 1 Connector	16.	USB Ports (WiFi Dongle (5V/0.9A)/ Media Player)
8.	Audio In 2 Connector	17.	RJ-45 Connector
9.	3D Sync Connector	18.	Power Socket

INTRODUCTION

Keypad

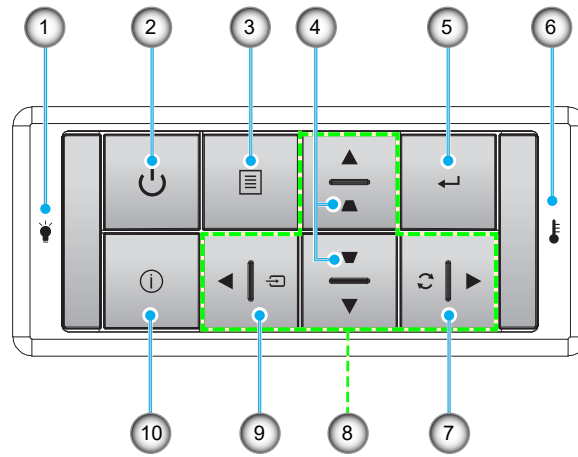

No	Item	No	Item
1.	Lamp LED	6.	Temp LED
2.	Power and Power LED	7.	Re-Sync
3.	Menu	8.	Four Directional Select Keys
4.	Keystone Correction	9.	Source
5.	Enter	10.	Information

INTRODUCTION

Remote control

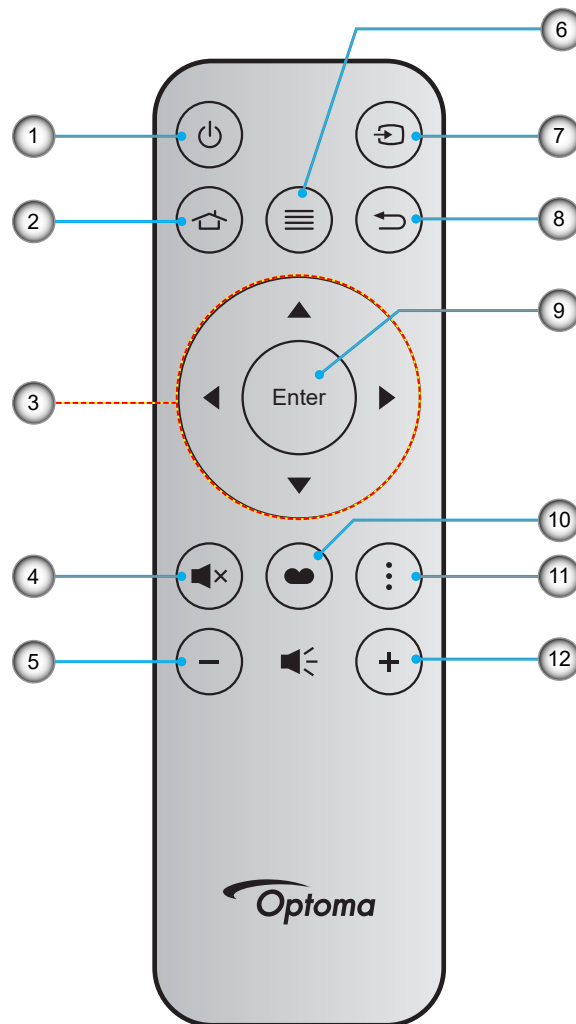

No	Item	No	Item
1.	Power On / Off	7.	Source
2.	Home	8.	Return
3.	Four Directional Select Keys	9.	Enter
4.	Mute	10.	Display Mode
5.	Volume -	11.	APP menu
6.	Menu	12.	Volume +

Note:

- Some keys may have no function for models that do not support these features.
- Before using the remote control for the first time, remove the transparent insulation tape. See page 18 for battery installation.

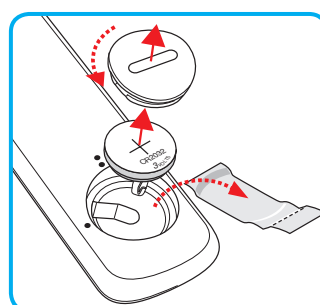

SETUP AND INSTALLATION

Installing the projector

Your projector is designed to be installed in one of four possible positions.

Your room layout or personal preference will dictate which installation location you select. Take into consideration the size and position of your screen, the location of a suitable power outlet, as well as the location and distance between the projector and the rest of your equipment.

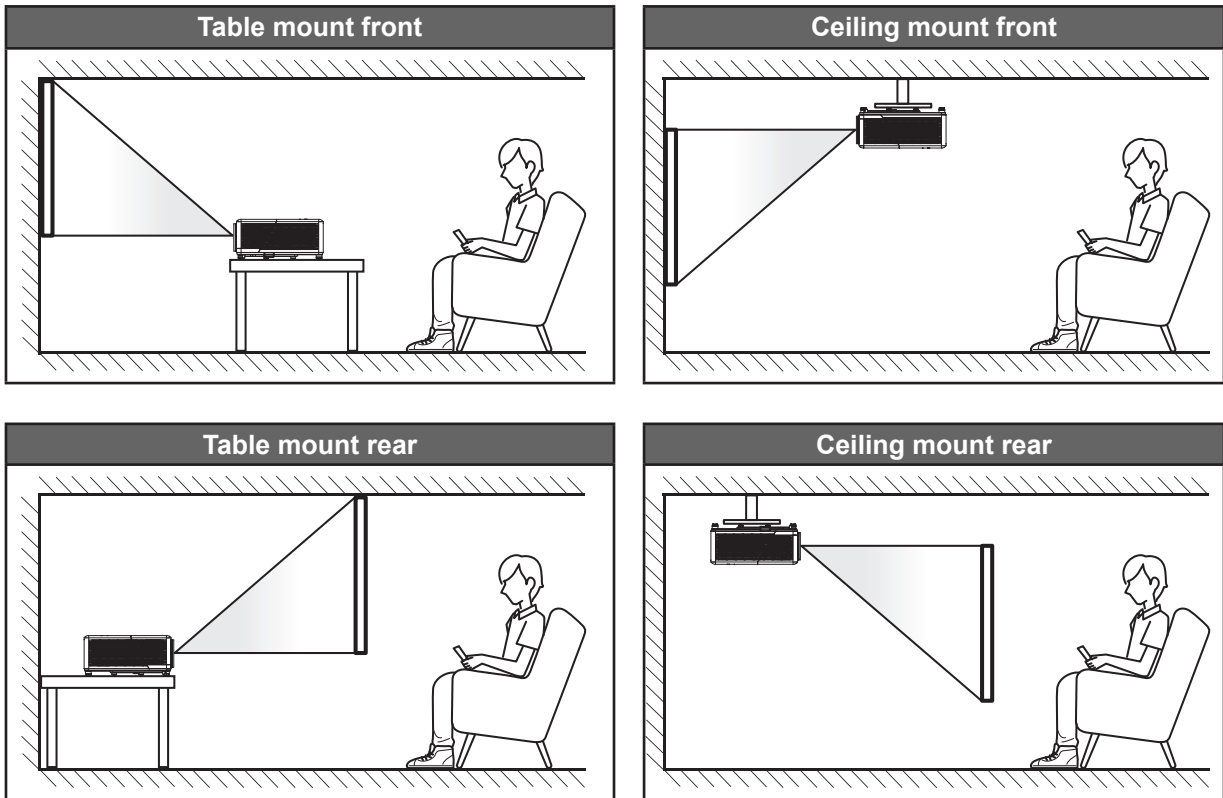

Projector should be placed flat on a surface and 90 degrees / perpendicular to the screen.

- How to determine projector location for a given screen size, please refer to distance table on page 73.
- How to determine screen size for a given distance, please refer to distance table on page 73.

Note: *The further away the projector is placed from the screen the projected image size increases and vertical offset also increases proportionally.*

SETUP AND INSTALLATION

Projector installation notice

- 360° free orientation operation

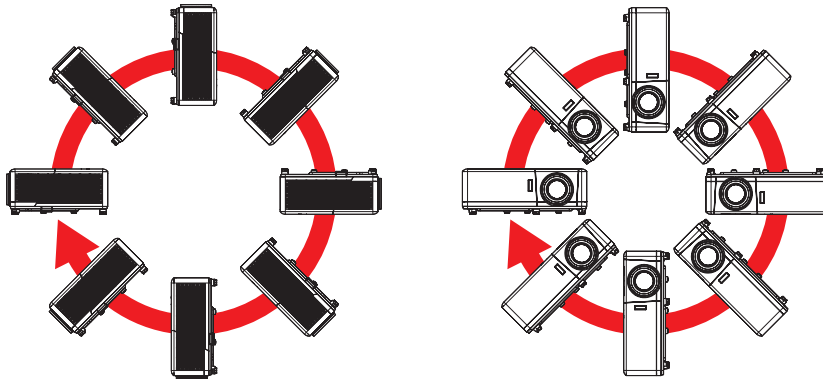

- Allow at least 30 cm clearance around the exhaust vent.

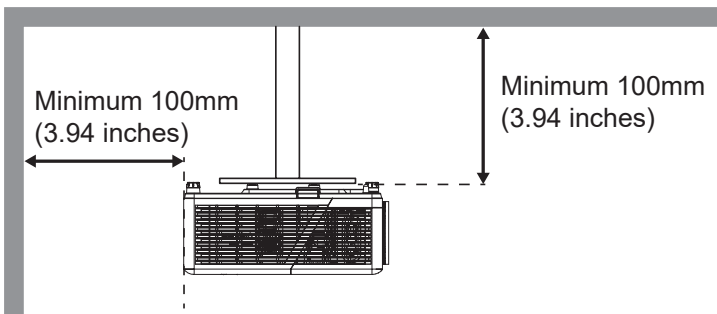
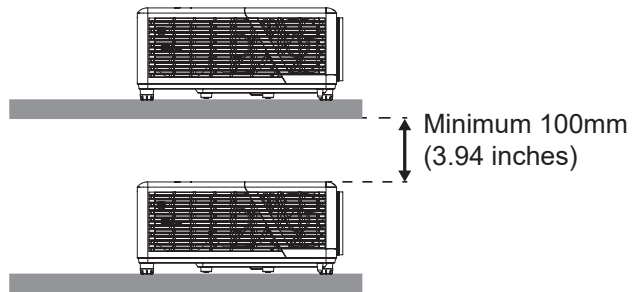
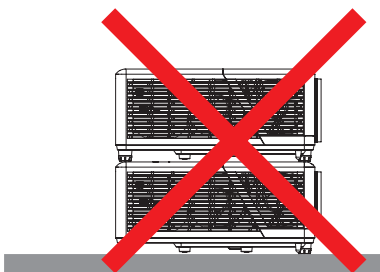
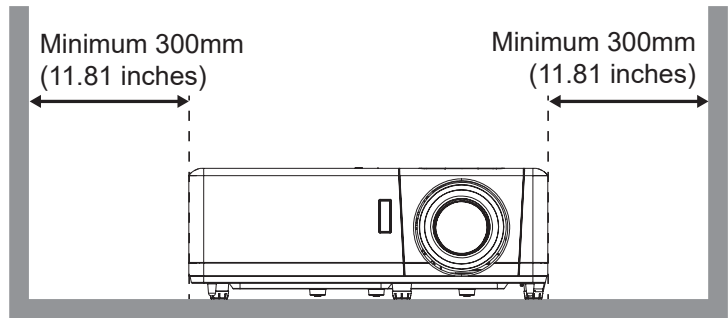
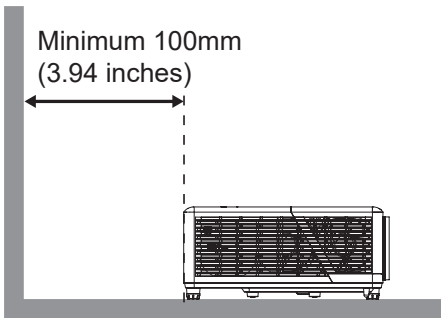

- Ensure that the intake vents do not recycle hot air from the exhaust vent.
- When operating the projector in an enclosed space, ensure that the surrounding air temperature within the enclosure does not exceed operation temperature while the projector is running, and the air intake and exhaust vents are unobstructed.
- All enclosures should pass a certified thermal evaluation to ensure that the projector does not recycle exhaust air, as this may cause the device to shutdown even if the enclosure temperature is within the acceptable operation temperature range.

SETUP AND INSTALLATION

Connecting sources to the projector

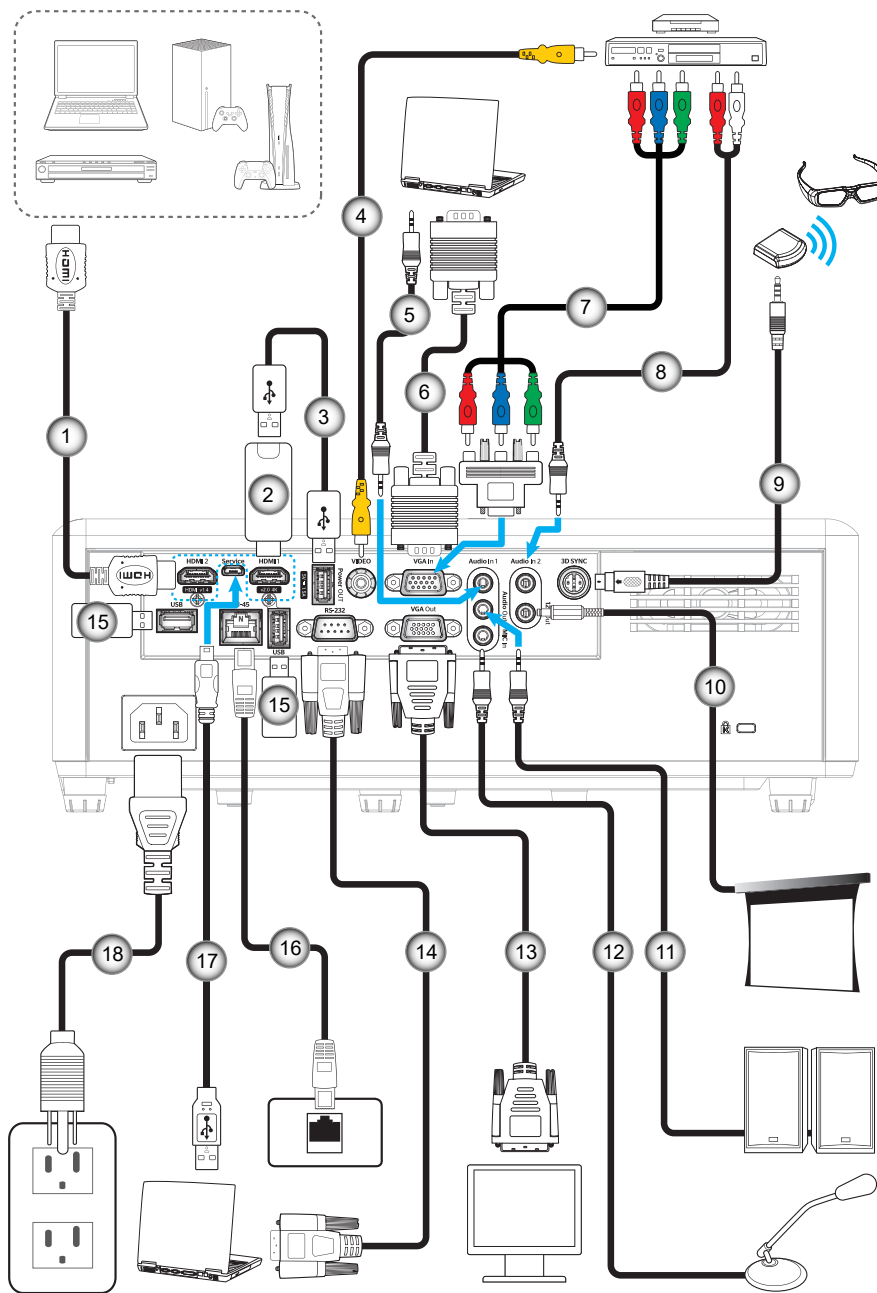

No	Item	No	Item
1.	HDMI Cable	10.	12V DC Jack
2.	HDMI Dongle	11.	Audio Out Cable
3.	USB Power Cable	12.	Microphone Cable
4.	Video Cable	13.	VGA Out Cable
5.	Audio In Cable	14.	RS232 Cable
6.	VGA In Cable	15.	USB Disk Drive / WiFi Dongle
7.	RCA Component Cable	16.	RJ-45 Cable
8.	Audio In Cable	17.	USB Cable
9.	3D Emitter Cable	18.	Power Cord

Note: To ensure the best image quality and avoid connection errors, we recommend the use of High Speed or Premium Certified HDMI cables up to 5 meters.

SETUP AND INSTALLATION

Adjusting the projector image

Image height

The projector is equipped with elevator feet for adjusting the image height.

1. Locate the adjustable foot you wish to adjust on the underside of the projector.
2. Rotate the adjustable foot clockwise or counterclockwise to raise or lower the projector.

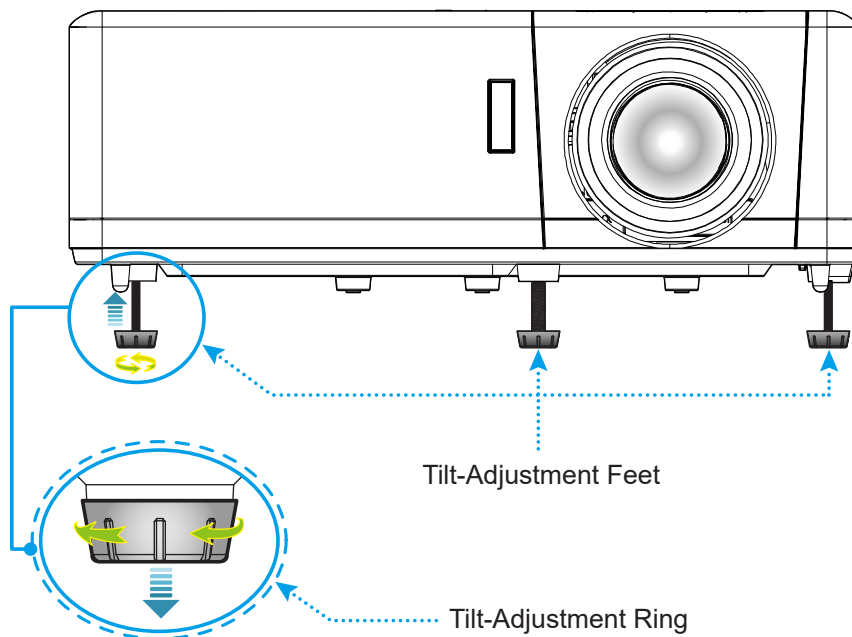

Zoom, lens shift, and focus

- To adjust the image size, turn the zoom lever clockwise or counterclockwise to increase or decrease the projected image size.
- To adjust the image position, turn the lens shift dial clockwise or counterclockwise to adjust the position of the projected image vertically.
- To adjust the focus, turn the focus ring clockwise or counterclockwise until the image is sharp and legible.

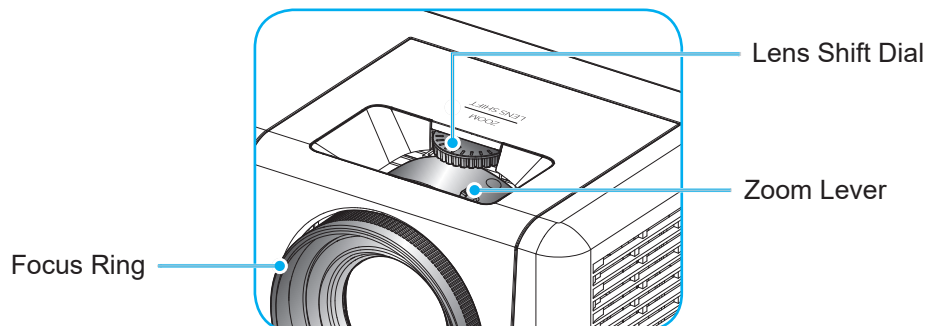

Note: The projector will focus at a distance of 1.2m to 8.1m.

SETUP AND INSTALLATION

Remote setup

Installing / replacing the battery

1. Use a coin to turn the battery cover counterclockwise until the cover opens.
2. Install new battery into the compartment.
Remove the old battery and install new one (CR2032). Ensure that the side with a "+" is facing up.
3. Put the cover back. Then use a coin to turn the battery cover clockwise to lock it in place.

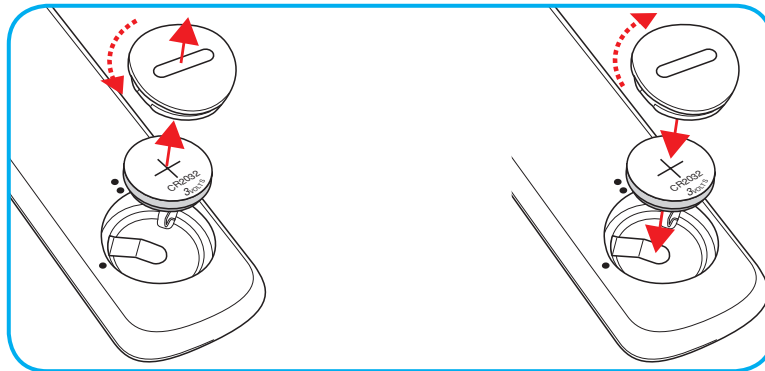

CAUTION:

To ensure safe operation, please observe the following precautions:

- Use CR2032 type battery.
- Avoid contact with water or liquid.
- Do not expose the remote control to moisture or heat.
- Do not drop the remote control.
- If the battery has leaked in the remote control, carefully wipe the case clean and install new battery.
- Risk of an explosion if battery is replaced by an incorrect type.
- Dispose of used battery according to the instructions.

Warning: Do not ingest battery, Chemical Burn Hazard.



- This product contains a coin / button cell battery. If the coin / button cell battery is swallowed, it can cause severe internal burns in just 2 hours and can lead to death.

Warning: Keep new and used batteries away from children.



- If the battery compartment does not close securely, stop using the product and keep it away from children. If you think batteries might have been swallowed or placed inside any part of the body, seek immediate medical attention.

SETUP AND INSTALLATION

Effective range

Infrared (IR) remote control sensor is located on the top and front sides of the projector. Ensure to hold the remote control at an angle within 30° (horizontally) or 20° (vertically) perpendicular to the projector's IR remote control sensor to function correctly. The distance between the remote control and the sensor should not be longer than 12 meters (39.4 feet).

- Make sure that there are no obstacles between the remote control and the IR sensor on the projector that might obstruct the infrared beam.
- Make sure the IR transmitter of the remote control is not being shined on directly by sunlight or fluorescent lamps.
- Please keep the remote control away from fluorescent lamps for over 2 m or the remote control might malfunction.
- If the remote control is close to Inverter-Type fluorescent lamps, it might become ineffective from time to time.
- If the remote control and the projector are within a very short distance, the remote control might become ineffective.
- When you aim at the screen, the effective distance is less than 5 m from the remote control to the screen and reflecting the IR beams back to the projector. However, the effective range might change according to screens.

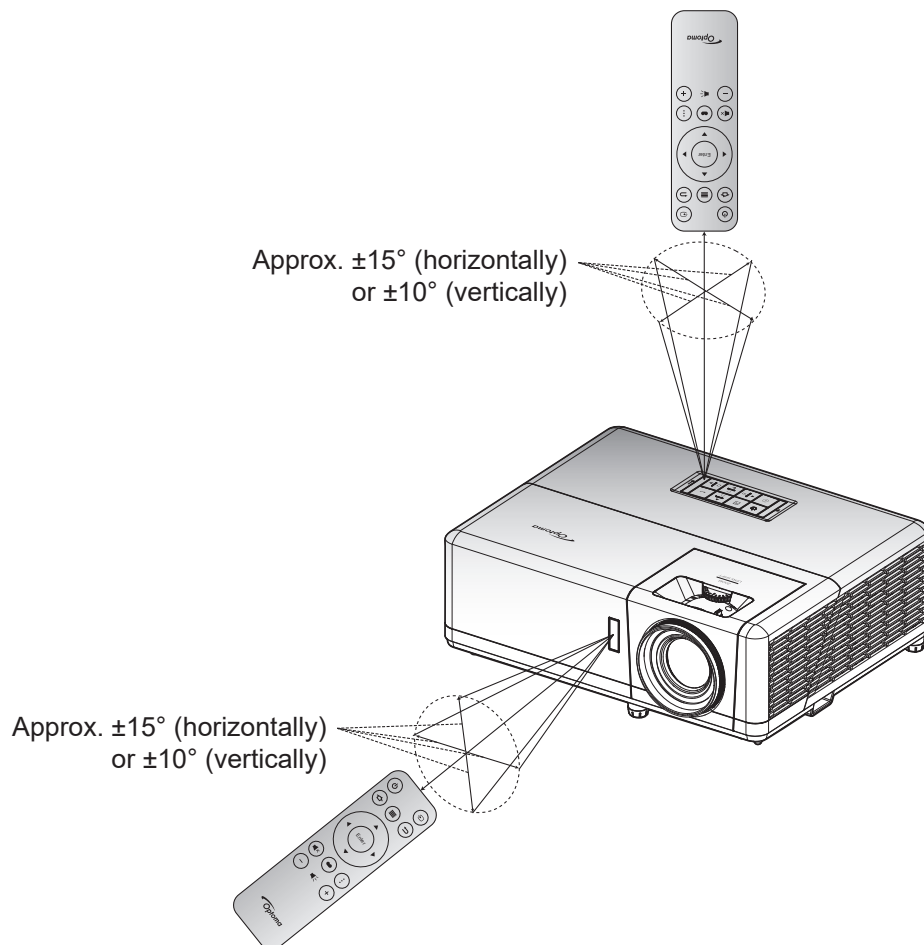

SETUP AND INSTALLATION

Initial setup

The first time the projector is turned on, you will be prompted to do the initial setup including selecting the projection orientation, preferred language, configuring network settings, and more. Once the **Setup Complete!** screen appears, the projector is ready to use.



[Projection orientation setup]

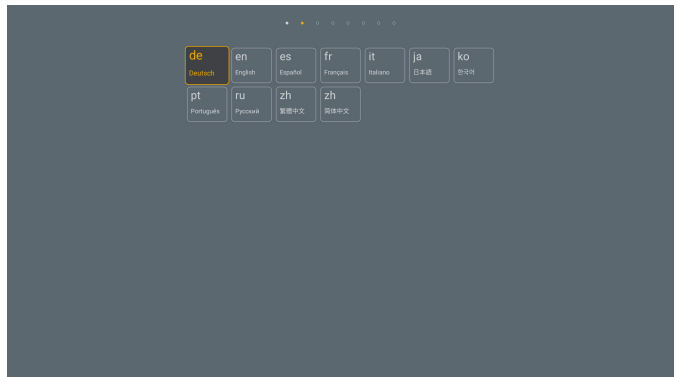

[Select your language]

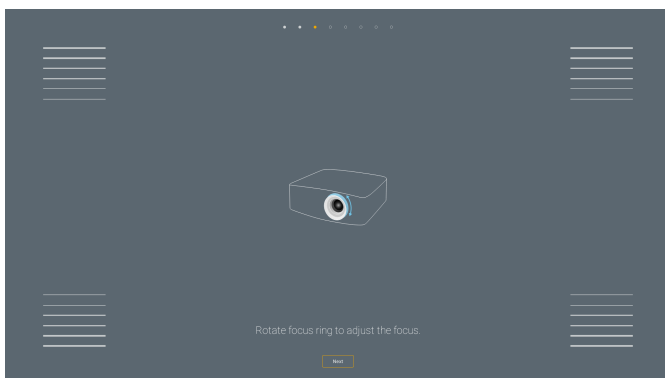

[Focus adjustment]

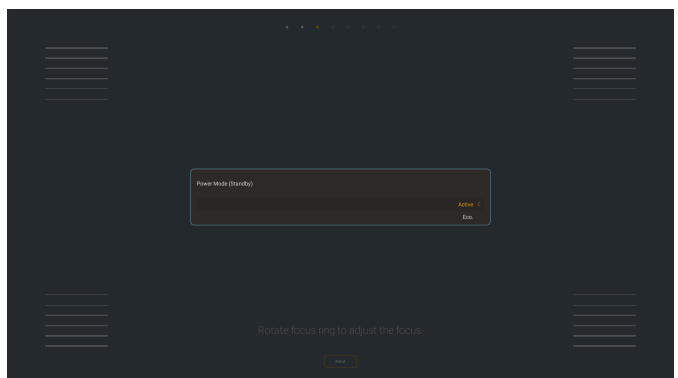

[Power Mode (Standby) selection]

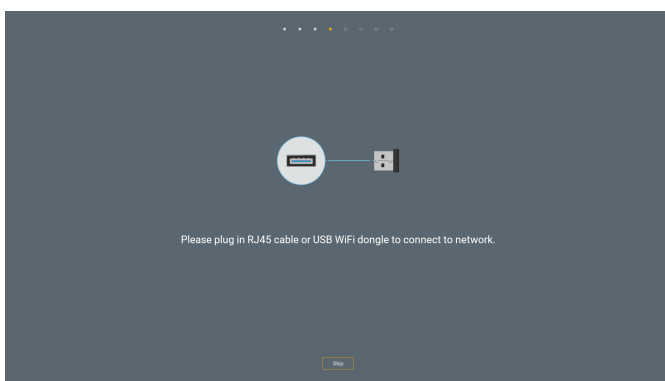

[Wi-Fi dongle installation]

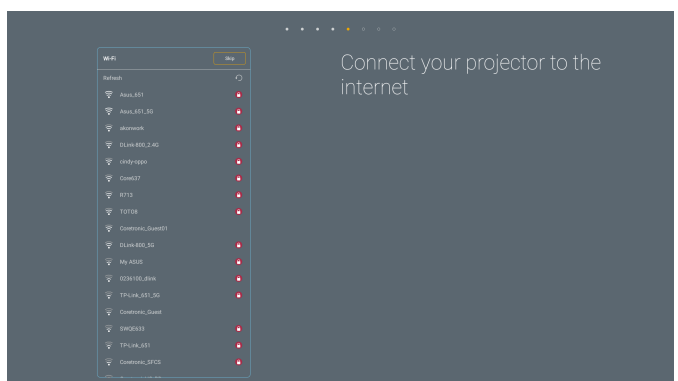

[Network setup]

SETUP AND INSTALLATION

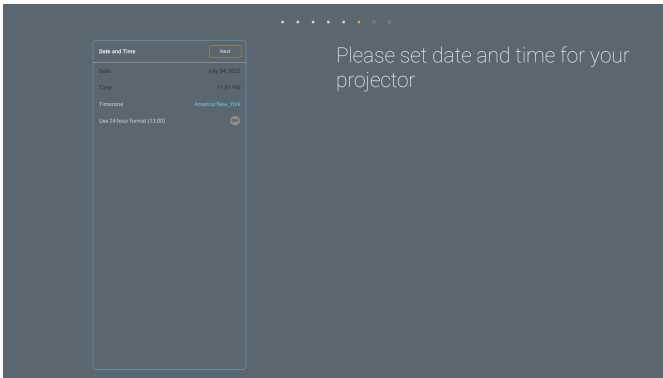

[Set the date and time]

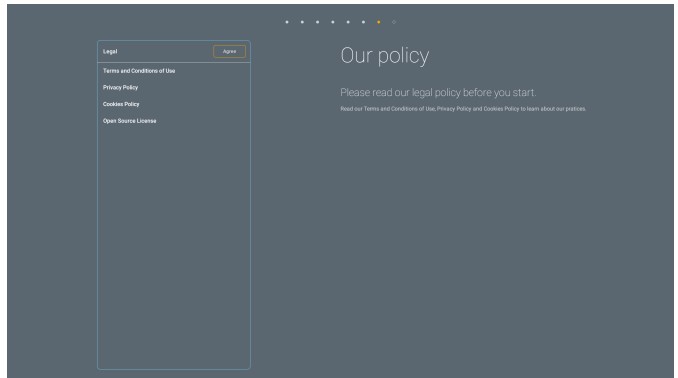

[Review & accept Optoma's Terms & Conditions and policies]

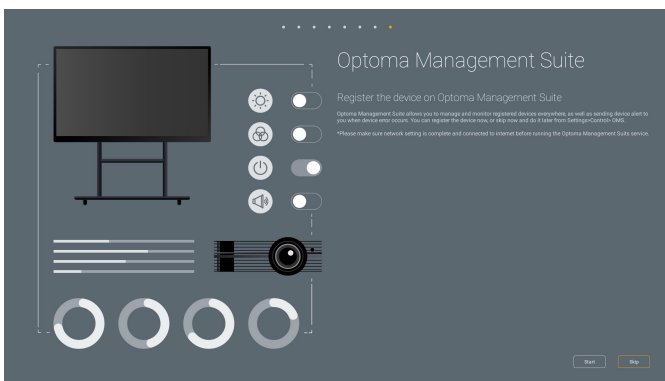

[Optoma Management Suite]

USING THE PROJECTOR

Powering on / off the projector

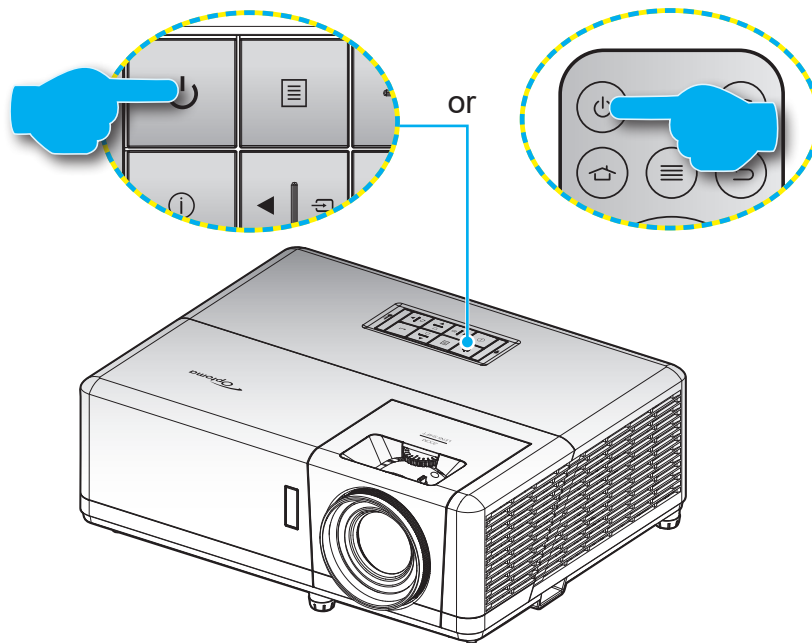

Powering on

1. Securely connect the power lead and signal/source cable. When connected, the Power LED will turn red.
2. Turn on the projector by pressing the \cup button on the projector keypad or remote control.
3. A start up screen will display in approximately 10 seconds and the Power LED will begin flashing blue.

Note: The first time the projector is turned on, you will be prompted to select the preferred language, projection orientation, and other settings.

Powering off

1. Turn off the projector by pressing the \cup button on the projector keypad or remote control.
2. The following message will be displayed:

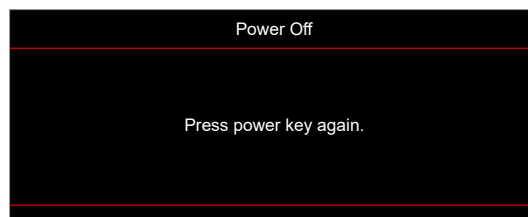

3. Press the \cup button again to confirm, otherwise the message will disappear after 15 seconds. When you press the \cup button for the second time, the projector will shut down.
4. The cooling fans will continue to operate for about 1 second for the cooling cycle and the Power LED will flash blue. When the Power LED turns solid red, this indicates the projector has entered standby mode. If you wish to turn the projector back on, you must wait until the cooling cycle has finished and the projector has entered standby mode. When the projector is in standby mode, simply press the \cup button again to turn on the projector.
5. Disconnect the power lead from the electrical outlet and the projector.

Note: It is not recommended that the projector be turned on immediately, right after a power off procedure.

USING THE PROJECTOR

Selecting an input source

Turn on the connected source that you want to display on the screen, such as computer, notebook, video player, etc. The projector will automatically detect the source. If multiple sources are connected, press the  button on the projector keypad or the remote control to select the desired input.

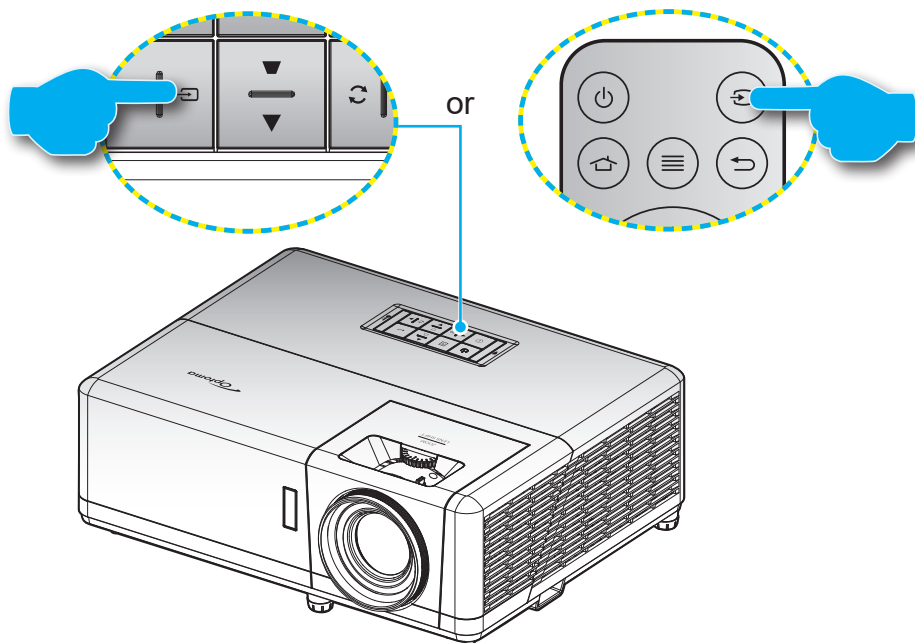

USING THE PROJECTOR

Home screen overview

The Home screen is displayed every time you start the projector. It contains system date and time, system status, icons to access OSD menu, projector settings menu, apps, input sources, and more.

To navigate the Home screen, simply use the buttons on the remote control.

You can return to the Home screen at any time by pressing “” on the remote control, regardless of your position in the user interface.

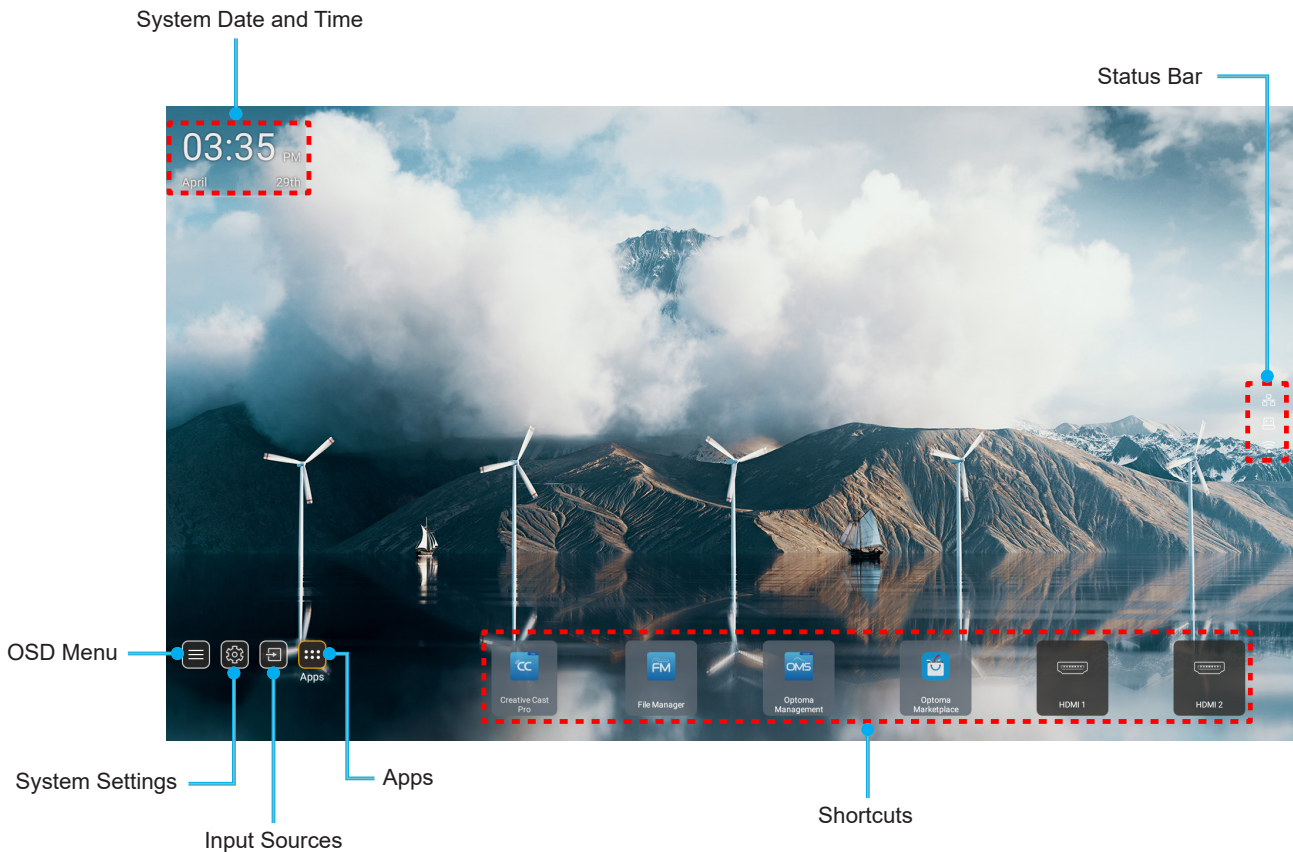

Note: The selected menu or item is highlighted in orange color, for example “Apps” on the image above.

System date and time

Date and time is displayed on the Home screen if the projector is connected to the network. The default setting is 10:00am, 2019/01/01. AM/PM will appear only if the 24-hour format is off.

To modify date and time parameters, select the respective field on the screen. The Date and Time settings page opens automatically. Then perform the modifications.

USING THE PROJECTOR

Projector settings menu (OSD)

Press “≡” on the remote control or on the Home screen, select the OSD menu “≡” to review projector information or manage various settings related to the image, display, 3D, audio, and setup.

General menu navigation

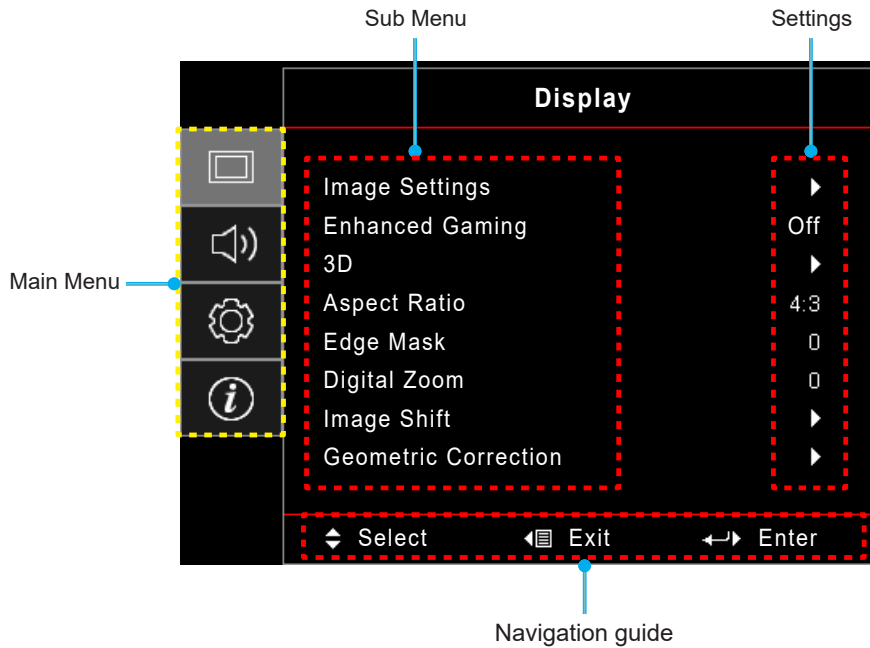

1. When the OSD menu is displayed, use the up and down navigation buttons to select any item in the main menu. While making a selection on a particular page, press “OK” to enter submenu.
2. Press the “Left” and “Right” button to select the desired menu item. Then press “OK” to open its submenu.
3. Press the “Up” and “Down” button to select the desired item in the sub menu.
4. Press the “OK” button to enable or disable a setting or press the “Left” and “Right” button to adjust a value.
5. Select the next item to be adjusted in the sub menu and modify as described above.
6. To exit, press “↵” (repeatedly if necessary). The OSD menu will close and the projector will automatically save the new settings.

USING THE PROJECTOR

OSD Menu tree



Note: The OSD menu tree items and features are subject to models and region. Optoma reserves the right to add or remove items to improve product performance without notice.

Main Menu	Sub Menu	Sub Menu 2	Sub Menu 3	Sub Menu 4	Values			
Display	Image Settings	Display Mode			Presentation			
					Bright			
					HDR			
					HLG			
					Cinema			
					Game			
					sRGB			
					DICOM SIM.			
					User			
				3D				
			Wall Color			Off [Default]		
						Blackboard		
						Light Yellow		
						Light Green		
						Light Blue		
						Pink		
			Dynamic Range	HDR / HLG			Off	
							Auto [Default]	
				HDR Picture Mode			Bright	
							Standard [Default]	
							Film	
							Detail	
				HLG Picture Mode			Bright	
							Standard [Default]	
							Film	
						Detail		
				Brightness			-50 ~ 50	
				Contrast			-50 ~ 50	
				Sharpness			1 ~ 15	
				Color			-50 ~ 50	
				Tint			-50 ~ 50	
			Gamma		Film			
					Video			
					Graphics			
					Standard(2.2)			
		1.8						
		2.0						
		2.4						
		2.6						

USING THE PROJECTOR

Main Menu	Sub Menu	Sub Menu 2	Sub Menu 3	Sub Menu 4	Values	
Display	Image Settings	Color Settings	BrilliantColor™		1 ~ 10	
			Color Temperature		Warm	
					Standard	
					Cool	
					Cold	
			Color Matching	Color		Red [Default]
						Green
						Blue
						Cyan
						Yellow
						Magenta
						White(*)
					Hue / R(*)	-50 ~ 50 [Default: 0]
					Saturation / G(*)	-50 ~ 50 [Default: 0]
					Gain / B(*)	-50 ~ 50 [Default: 0]
					Reset	Cancel [Default]
				OK		
				Exit		
			RGB Gain/Bias	Red Gain	-50 ~ 50	
				Green Gain	-50 ~ 50	
				Blue Gain	-50 ~ 50	
				Red Bias	-50 ~ 50	
				Green Bias	-50 ~ 50	
				Blue Bias	-50 ~ 50	
				Reset	Cancel [Default]	
					Yes	
			Exit			
			Color Space [Not HDMI Input]		Auto [Default]	
					RGB	
					YUV	
			Color Space [HDMI Input]		Auto [Default]	
					RGB(0~255)	
					RGB(16~235)	
					YUV	
			White Level	0 ~ 31		
			Black Level	-5 ~ 5		
			IRE		0	
					7.5	
			Signal	Automatic	Off	
					On [Default]	
				Frequency	-10 ~ 10 (depends on signal) [Default: 0]	
			Phase	0~31 (depends on signal) [Default: 0]		

USING THE PROJECTOR

Main Menu	Sub Menu	Sub Menu 2	Sub Menu 3	Sub Menu 4	Values		
Display	Image Settings	Signal	H. Position		-5 ~ 5 (depends on signal) [Default: 0]		
			V. Position		-5 ~ 5 (depends on signal) [Default: 0]		
		Brightness Mode			DynamicBlack		
					Eco.		
					Constant Power (Power = 100%/ 95%/ 90%/ 85%/ 80%/ 75%/ 70%/ 65%/ 60%/ 55%/ 50%)		
		Reset			Constant Luminance (Power =85%/80%/75%/70%)		
					Cancel [Default]		
		Enhanced Gaming				Yes	
						Off [Default]	
		3D	3D Mode				Off
						On [Default]	
	3D Tech					DLP-Link [Default]	
						3D Sync	
	3D → 2D					3D [Default]	
						L	
					R		
	3D Format					Auto [Default]	
						SBS	
						Top and Bottom	
						Frame Sequential	
	3D Sync Invert					On	
						Off [Default]	
	Reset					Cancel [Default]	
						OK	
	Aspect Ratio						4:3
							16:9
							LBX
						Native	
						Auto [Default]	
	Edge Mask					0 ~ 10 [Default: 0]	
	Digital Zoom					-5 ~ 25 [Default: 0]	
	Image Shift	H 				-100 ~ 100 [Default: 0]	
		V 				-100 ~ 100 [Default: 0]	
	Geometric Correction	Four Corners					
		H Keystone				LT:-30 ~ 30 ST:-15~15 [Default: 0]	
		V Keystone				LT:-30 ~ 30 ST:-15~15 [Default: 0]	
		Auto Keystone				Off	
						On [Default]	





USING THE PROJECTOR

Main Menu	Sub Menu	Sub Menu 2	Sub Menu 3	Sub Menu 4	Values	
Display	Geometric Correction	Reset			Cancel [Default]	
					OK	
Audio	Mute				Off [Default]	
					On	
	Volume					0 ~ 10 [Default: 5]
		HDMI1				Audio 1
					Audio 2	
					Default [Default]	
					MIC	
	HDMI2					Audio 1
						Audio 2
						Default [Default]
						MIC
	VGA					Audio 1 [Default]
						Audio 2
						MIC
	Video					Audio 1
						Audio 2 [Default]
					MIC	
Setup	Projection				Front  [Default]	
					Rear 	
					Ceiling-top 	
					Rear-top 	
	Power Settings	Direct Power On				Off [Default]
						On
		Signal Power On				Off [Default]
						On
		Auto Power Off (min.)				0 ~ 180 (5 min increments) [Default: 20]
		Sleep Timer (min.)				0 ~ 990 (30 min increments) [Default: 0]
			Always On			
						Yes
	Power Mode (Standby)					Active
						Eco [Default]
	USB Power (Standby)					Off [Default]
						On
	Security	Security				Off
						On
		Security Timer	Month			
			Day			
Hour						
Change Password				[Default: 1234]		

USING THE PROJECTOR

Main Menu	Sub Menu	Sub Menu 2	Sub Menu 3	Sub Menu 4	Values	
Setup	HDMI Link Settings	HDMI Link			Off [Default]	
					On	
		Inclusive of TV			No [Default]	
					Yes	
		Power On Link			Mutual [Default]	
					PJ → Device	
					Device → PJ	
		Power Off Link			Off [Default]	
					On	
		Test Pattern				Green Grid
						Magenta Grid
						White Grid
					White	
	Projector ID				Off	
	12V Trigger				00 ~ 99	
					Off	
	Options	Language				On
						English [Default]
						Deutsch
						Français
						Italiano
						Español
						Português
						Polski
						Nederlands
						Svenska
						Norsk/Dansk
						Suomi
						ελληνικά
						繁體中文
						簡體中文
						日本語
						한국어
					Русский	
					Magyar	
					Čeština	
			عربي			
			ไทย			
			Türkçe			
			فارسی			
			Tiếng Việt			
			Bahasa Indonesia			
			Română			
			Slovenčina			

USING THE PROJECTOR

Main Menu	Sub Menu	Sub Menu 2	Sub Menu 3	Sub Menu 4	Values	
Setup	Options	Closed Captioning			CC1	
					CC2	
					Off [Default]	
		Menu Settings	Menu Location			Top left 
						Top right 
						Center  [Default]
						Bottom left 
						Bottom right 
						Off
			Menu Timer			5sec
						10sec [Default]
						Off
		Auto Source			Off [Default]	
					On	
		Input Source			HDMI1	
					HDMI2	
					VGA	
					Video	
					HOME	
		Input Name	HDMI1			Default [Default]
						Custom
			HDMI2			Default [Default]
						Custom
			VGA			Default [Default]
						Custom
			Video			Default [Default]
						Custom
			HOME			Default [Default]
						Custom
		High Altitude			Off [Default]	
					On	
		Display Mode Lock			Off [Default]	
					On	
		Keypad Lock			Off [Default]	
					On	
		Information Hide			Off [Default]	
					On	
		Logo			Default [Default]	
					Neutral	
					User	

USING THE PROJECTOR

Main Menu	Sub Menu	Sub Menu 2	Sub Menu 3	Sub Menu 4	Values
Setup	Options	Background Color			None
					Blue [Default]
					Red
					Green
					Gray
					Logo
	Reset	Reset OSD			Cancel [Default]
					OK
		Reset to Default			Cancel [Default]
					OK
Info	Regulatory				
	Serial Number				
	Source				
	Resolution				00x00
	Refresh Rate				0.00Hz
	Display Mode				
	Power Mode (Standby)				
	Light Source Hours				0 hr
	Network Status				
	IP Address				
	Projector ID				00~99
	Brightness Mode				
	FW Version	System			
Android					
MCU					

USING THE PROJECTOR

Display menu

Image settings menu

Display Mode

There are several predefined display modes that you can choose from to suit your viewing preference. Each mode has been fine-tuned by our expert colour team to ensure superior colour performance for wide range of content.

- **Presentation:** This mode is suitable for most presenting needs for business and education environments.
- **Bright:** This mode is suitable for environments where extra-high brightness is required, such as using the projector in well-lit rooms.
- **HDR / HLG:** Decodes and displays High Dynamic Range (HDR) / Hybrid Log Gamma (HLG) content for the deepest blacks, brightest whites, and vivid cinematic color using REC.2020 color gamut. This mode will be automatically enabled if HDR/HLG is set to Auto (and HDR/HLG Content is sent to projector – 4K UHD Blu-ray, 1080p/4K UHD HDR/HLG Games, 4K UHD Streaming Video). While HDR/HLG mode is active, other display modes (Cinema, Reference, etc.) cannot be selected as HDR/HLG delivers color that is highly accurate, exceeding the color performance of the other display modes.
- **Cinema:** Provides the best balance of detail and colors for watching movies.
- **Game:** Optimises your projector for maximum contrast and vivid colours allowing you to see shadow detail when playing video games.
- **sRGB:** Standardized accurate color.
- **DICOM SIM.:** This mode has been created for viewing greyscale images, perfect for viewing X-rays and scans during medical training*.
Note: **This projector is not suitable for use in medical diagnosis.*
- **User:** Memorizes user defined setting, tailor your own display mode settings.
- **3D:** Optimized settings for watching 3D content.
Note: *To experience the 3D effect, you will need to have compatible DLP Link 3D glasses. See 3D section for more information.*

Wall Color

Designed to adjust the colors of the projected image when projecting on to a wall without a screen. Each mode has been fine-tuned by our expert colour team to ensure superior color performance.

There are several predefined modes that you can choose from to suit the colour of your wall. Select between off, blackboard, light yellow, light green, light blue, pink, and gray.

Note: *For accurate color reproduction, we recommend using a screen.*

Dynamic Range

Configure the High Dynamic Range (HDR) / Hybrid Log Gamma(HLG) setting and its effect when displaying videofrom 4K Blu-ray players and streaming devices.

Note: *Only HDMI supports the Dynamic Range function.*

➤ HDR / HLG

- **Off:** Turn off HDR/HLG Processing. When set to Off, the projector will NOT decode HDR/HLG content.
- **Auto:** Auto detect HDR/HLG signal.

➤ HDR Picture Mode / HLG Picture Mode

- **Bright:** Choose this mode for brighter more saturated colors.
- **Standard:** Choose this mode for natural looking colors with a balance of warm and cool tones.

USING THE PROJECTOR

- **Film:** Choose this mode for improved detail and image sharpness.
- **Detail:** The signal comes from OETF conversion to achieve the best color matching.

Brightness

Adjust the brightness of the image.

Contrast

The contrast controls the degree of difference between the lightest and darkest parts of the picture.

Sharpness

Adjust the sharpness of the image.

Color

Adjust a video image from black and white to fully saturated color.

Tint

Adjust the color balance of red and green.

Gamma

Set up gamma curve type. After the initial setup and fine tuning is completed, utilize the Gamma Adjustment steps to optimize your image output.

- **Film:** For home theater.
- **Video:** For video or TV source.
- **Graphics:** For PC / Photo source.
- **Standard(2.2):** For standardized setting.
- **1.8 / 2.0 / 2.4 / 2.6:** For specific PC / Photo source.

Color Settings

Configure the color settings.

- **BrilliantColor™:** This adjustable item utilizes a new color-processing algorithm and enhancements to enable higher brightness while providing true, more vibrant colors in picture.
- **Color Temperature:** Select a color temperature from Warm, Standard, Cool, or Cold.
- **Color Matching:** Select the following options:
 - Color: Adjust the red, green, black, cyan, yellow, magenta, and white level of the image.
 - Hue / R(red)*: Adjust the color balance of red and green.
Note: **If the **Color** setting is set to **White**, you can adjust the red color setting.*
 - Saturation / G(green)*: Adjust a video image from black and white to fully saturated color.
Note: **If the **Color** setting is set to **White**, you can adjust the green color setting.*
 - Gain / B(blue)*: Adjust the image brightness.
Note: **If the **Color** setting is set to **White**, you can adjust the blue color setting.*
 - Reset: Return the factory default settings for color matching.
 - Exit: Exit the “Color Matching” menu.
- **RGB Gain/Bias:** This settings allows to configure the brightness (gain) and contrast (bias) of an image.
 - Reset: Return the factory default settings for RGB gain/bias.
 - Exit: Exit the “RGB Gain/Bias” menu.
- **Color Space (non-HDMI input only):** Select an appropriate color matrix type from the following: Auto, RGB, or YUV.

USING THE PROJECTOR

- **Color Space (HDMI input only):** select an appropriate color matrix type from the following: Auto, RGB(0-255), RGB(16-235), and YUV.
- **White Level:** Allow user to adjust White Level when inputting Video signals.
Note: *White level can only be adjusted for Video/S-Video input sources.*
- **Black Level:** Allow user to adjust Black Level when inputting Video signals.
Note: *Black level can only be adjusted for Video/S-Video input sources.*
- **IRE:** Allow user to adjust IRE value when inputting Video signals.
Note:
 - *IRE is only available with NTSC video format.*
 - *IRE can only be adjusted for Video/S-Video input sources.*

Signal

Adjust the signal options.

- **Automatic:** Configure automatically the signal (the frequency and phase items are grayed out). If automatic is disabled, the frequency and phase items will appear for tuning and saving the settings.
- **Frequency:** Change the display data frequency to match the frequency of your computer's graphic card. Use this function only if the image appears to flicker vertically.
- **Phase:** Synchronize the signal timing of the display with the graphic card. If the image appears to be unstable or flickers, use this function to correct it.
- **H. Position:** Adjust the horizontal positioning of the image.
- **V. Position:** Adjust the vertical positioning of the image.

Note: *This menu is only available if the input source is RGB/Component.*

Brightness Mode

Adjust the brightness mode settings.

- **DynamicBlack:** Use to automatically adjust the picture brightness in order to give optimum contrast performance.
- **Eco.:** Choose "Eco." to dim the projector laser diode which will lower power consumption and extend the laser diode life.
- **Constant Power:** Choose the power percentage for brightness mode.
- **Constant Luminance:** Constant Luminance varies the strength of LD luminance such that the brightness maintains consistent with time.

Reset

Return the factory default settings for color settings.

USING THE PROJECTOR

Enhanced gaming menu

Enhanced Gaming

Enable this feature to reduce response times (input latency) during gaming to 8.2ms (1080p@120Hz). All geometry settings (example: Keystone, Four Corners) will be disabled when Enhanced Gaming Mode is enabled. See additional information below.

Note:

- The input lag by signals is described in the following table:
- The values in the table can vary slightly.

Source Timing (HDMI1)	Enhanced Gaming	Output	Output Resolution	Input Lag
1080p60	On	1080p60Hz	1080p	16.2ms
1080p120	On	1080p120Hz	1080p	8.2ms
4K60	On	1080p60Hz	1080p	16.8ms
1080p60	Off	1080p60Hz	1080p	49.5ms
1080p120	Off	1080p120Hz	1080p	24.8ms
4K60	Off	1080p60Hz	1080p	49.9ms

Source Timing (HDMI2)	Enhanced Gaming	Output	Output Resolution	Input Lag
1080p60	On	1080p60Hz	1080p	16.2ms
1080p120	On	1080p120Hz	1080p	8.2ms
1080p60	Off	1080p60Hz	1080p	49.5ms
1080p120	Off	1080p120Hz	1080p	24.8ms

- Please note that if “Enhanced Gaming” mode is enabled, the 3D, Aspect Ratio, Edge Mask, Digital Zoom, Image Shift, and Geometric Correction functions are disabled automatically. These functions and settings will be restored when “Enhanced Gaming Mode” is disabled.

USING THE PROJECTOR

3D menu

Note:

- *This projector is a 3D ready projector with DLP-Link 3D solution.*
- *Please make sure your 3D glasses are use for DLP-Link 3D before enjoy your video.*
- *This projector supports frame sequential (page-flip) 3D via HDMI1/HDMI2/VGA ports.*
- *To enable 3D mode, the input frame rate should be set to 60Hz only, lower or higher frame rate is not supported.*
- *To reach the best performance, resolution 1920x1080 is recommended, please be noted that 4K (3840x2160) resolution is not supported in 3D mode.*

3D Mode

Use this option to disable or enable the 3D function.

- **Off:** Select “Off” to turn off 3D mode.
- **On:** Select “On” to turn on 3D mode.

3D Tech

Use this option to select 3D technology.

- **DLP-Link:** Select to use optimized settings for DLP 3D Glasses.
- **3D Sync:** Select to use optimized settings for IR, RF or polarized 3D Glasses.

3D → 2D

Use this option to specify how the 3D content should appear on the screen.

- **3D:** Display 3D signal.
- **L (Left):** Display the left frame of 3D content.
- **R (Right):** Display the right frame of 3D content.

3D Format

Use this option to select the appropriate 3D format content.

- **Auto:** When a 3D identification signal is detected, the 3D format is selected automatically.
- **SBS:** Display 3D signal in “Side-by-Side” format.
- **Top and Bottom:** Display 3D signal in “Top and Bottom” format.
- **Frame Sequential:** Display 3D signal in “Frame Sequential” format.

3D Sync Invert

Use this option to enable/disable the 3D sync invert function.

Reset

Return the 3D settings to factory default.

- **Cancel:** Select to cancel Reset.
- **OK:** Select to return the 3D settings to factory default.

USING THE PROJECTOR

Aspect ratio menu

Aspect Ratio

Select the aspect ratio of the displayed image between the following options:

- **4:3:** This format is for 4:3 input sources.
- **16:9:** This format is for 16:9 input sources, like HDTV and DVD enhanced for Wide screen TV.
- **LBX:** This format is for non-16x9, letterbox source and if you use external 16x9 lens to display 2.35:1 aspect ratio in full resolution.
- **Native:** This format displays the original image without any scaling.
- **Auto:** Automatically selects the appropriate display format.

Note: Detailed information about LBX mode:

- Some Letter-Box Format DVDs are not enhanced for 16x9 TVs. In this situation, the image will not look right when displaying image in 16:9 mode. In this situation, please try to use the 4:3 mode to view the DVD. If the content is not 4:3, there will be black bars around the image in 16:9 display. For this type of content, you can use LBX mode to fill the image on the 16:9 display.
- If you use an external anamorphic lens, this LBX mode also allows you to watch a 2.35:1 content (include Anamorphic DVD and HDTV film source) that supports anamorphic wide is enhanced for 16x9 Display in a wide 2.35:1 image. In this case, there are no black bars. Light source power and vertical resolution are fully utilized.

1080p scaling table:

16:9 screen	480i/p	576i/p	1080i/p	720p	PC
4x3	Scale to 1440x1080.				
16x9	Scale to 1920x1080.				
Native mode	- 1:1 mapping centered. - No scaling will be made; the image is displayed with the resolution based on input source.				

1080p auto mapping rule:

Auto	Input resolution		Auto/Scale	
	H-resolution	V-resolution	1920	1080
4:3	640	480	1440	1080
	800	600	1440	1080
	1024	768	1440	1080
	1280	1024	1440	1080
	1400	1050	1440	1080
	1600	1200	1440	1080
Wide Laptop	1280	720	1920	1080
	1280	768	1800	1080
	1280	800	1728	1080
SDTV	720	576	1350	1080
	720	480	1620	1080
HDTV	1280	720	1920	1080
	1920	1080	1920	1080

USING THE PROJECTOR

Edge mask menu

Edge Mask

Use this function to remove the video encoding noise on the edge of video source.

Digital zoom menu

Digital Zoom

Use to reduce or magnify an image on the projection screen. Digital Zoom is not the same as optical zoom and a result in degradation of image quality.

Note: *Zoom settings are retained on power cycle of the projector.*

Image shift menu

Image Shift

Adjust the projected image position horizontally (H) or vertically (V).

Geometric correction menu

Four Corners

This setting allows the projected image to be adjusted from each corner to make a square image when the projection surface is not level.

Note: *While adjusting the Four Corners, the Digital Zoom, Aspect Ratio, and Image Shift menus are disabled. To enable Digital Zoom, Aspect Ratio, and Image Shift, reset the Four Corners settings to the factory defaults.*

H Keystone

Adjust image distortion horizontally and make a squarer image. Horizontal keystone is used to correct a keystone image shape in which the left and right borders of the image are unequal in length. This is intended for use with horizontally on-axis applications.

V Keystone

Adjust image distortion vertically and make a squarer image. Vertical keystone is used to correct a keystone image shape in which the top and bottom are slanted to one of the sides. This is intended when for use with vertically on-axis applications.

Auto Keystone

Correct keystone digitally to fit the projected image on the area on which you are projecting.

Note:

- *The image size will reduce slightly when adjusting the horizontal and vertical keystone.*
- *When the Auto Keystone is used, the Four Corner Adjustment function will be disabled.*

Reset

Return the factory default setting for Geometric Correction settings.

- **Cancel:** Select to cancel Reset.
- **OK:** Select to return the factory default settings for Geometric Correction.

USING THE PROJECTOR

Audio menu

Mute menu

Mute

Use this option to temporarily turn off the sound.

- **On:** Choose “On” to turn mute on.
- **Off:** Choose “Off” to turn mute off.

Note: “Mute” function affects both internal and external speaker volume.

Volume menu

Volume

Adjust the volume level.

Audio input menu

Audio Input

Select the audio input port for the video sources as follows:

- **HDMI1:** Audio 1, Audio 2, Default, or MIC.
- **HDMI2:** Audio 1, Audio 2, Default, or MIC.
- **VGA:** Audio 1, Audio 2, or MIC.
- **Video:** Audio 1, Audio 2, or MIC.

USING THE PROJECTOR

Setup menu

Projection menu

Projection

Select the preferred projection between front, rear, ceiling-top, and rear-top.

Power settings menu

Direct Power On

Choose “On” to activate Direct Power mode. The projector will automatically power on when AC power is supplied, without pressing the “Power” key on the projector keypad or on the remote control.

Signal Power On

Choose “On” to activate Signal Power mode. The projector will automatically power on when a signal is detected, without pressing the “Power” key on the projector Keypad or on the remote control.

Note:

- *If the “Signal Power On” option is turned “On”, the power consumption of the projector in standby mode will be over 3W.*
- *This function is applicable with VGA and HDMI sources.*

Auto Power Off (min.)

Sets the countdown timer interval. The countdown timer will start, when there is no signal being sent to the projector. The projector will automatically power off when the countdown has finished (in minutes).

Sleep Timer (min.)

Configure the sleep timer.

- **Sleep Timer (min.):** Sets the countdown timer interval. The countdown timer will start, with or without a signal being sent to the projector. The projector will automatically power off when the countdown has finished (in minutes).
Note: *The Sleep Timer is reset every time when the projector is powered off.*
- **Always On:** Check to set the sleep timer always on.

Power Mode (Standby)

Set the power mode setting.

- **Active:** Choose “Active” to return to normal standby.
- **Eco:** Choose “Eco.” to save power dissipation further < 0.5W.

USB Power (Standby)

Enable or disable the USB power function when the projector is in standby mode.

USING THE PROJECTOR

Security menu

Security

Enable this function to prompt for a password before using the projector.

- **On:** Choose “On” to use security verification when the turning on the projector.
- **Off:** Choose “Off” to be able to switch on the projector without password verification.

Note: The default password is 1234.

Security Timer

Can be select the time (Month/Day/Hour) function to set the number of hours the projector can be used. Once this time has elapsed you will be requested to enter your password again.

Change Password

Use to set or modify the password that is prompted when turning the projector on.

HDMI link settings menu

Note: When you connect HDMI CEC-compatible devices to the projector with HDMI cables, you can control them on the same power on or power off status using the HDMI Link control feature in the projector's OSD. This lets one device or multiple devices in a group power on or power off via HDMI Link Feature in a typical configuration, your DVD player may be connected to the projector through an amplifier or home theater system.

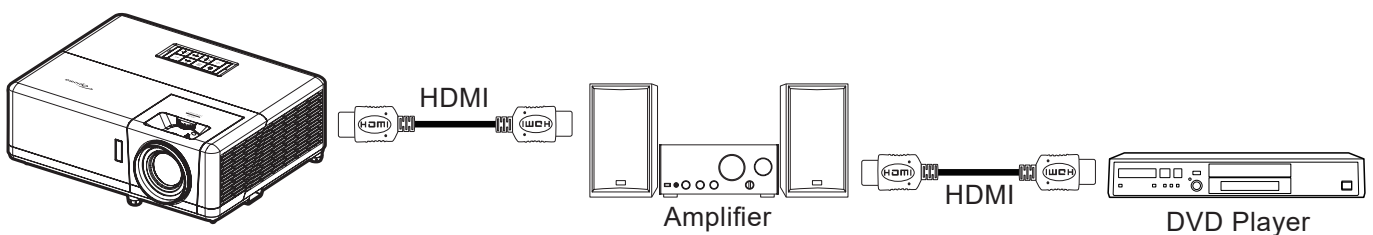

HDMI Link

Enable/disable the HDMI Link function.

Inclusive of TV

If the settings is set to “Yes” then the power on and power off link options are available.

Power On Link

CEC power on command.

- **Mutual:** Both projector and CEC device will be turned on simultaneously.
- **PJ → Device:** The CEC device will be turned on only after the projector is switched on.
- **Device → PJ:** The projector will be switched on only after the CEC device is turned on.

Power Off Link

Enable this function to let both HDMI Link and projector to be automatically turned off at the same time.

USING THE PROJECTOR

Test pattern menu

Test Pattern

Select the test pattern from green grid, magenta grid, white grid, white, or disable this function (off).

Projector ID menu

Projector ID

ID definition can be set up by menu (range 0-99), and allow user control an individual projector by using RS232 command.

Note: For a full list of RS232 commands, please refer to the RS232 user manual on our website.

12V trigger menu

12V Trigger

Use this function to enable or disable the trigger.

Note: 3.5mm mini jack that outputs 12V 500mA (max.) for relay system control.

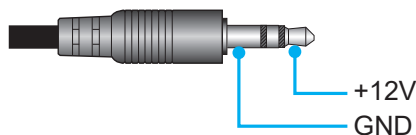

- **On:** Choose "On" to enable the trigger.
- **Off:** Choose "Off" to disable the trigger.

Options menu

Language

Select the multilingual OSD menu between English, German, French, Italian, Spanish, Portuguese, Polish, Dutch, Swedish, Norwegian, Danish, Finnish, Greek, Traditional Chinese, Simplified Chinese, Japanese, Korean, Russian, Hungarian, Czechoslovak, Arabic, Thai, Turkish, Farsi, Vietnamese, Indonesian, Romanian, and Slovakian.

Closed Captioning

Closed Captioning is a text version of the program sound or other information displayed on the screen. If the input signal contains closed captions, you can turn on the feature and watch the channels. The available options include "Off", "CC1", and "CC2".

Menu Settings

Set the menu location on the screen and configure menu timer settings.

- **Menu Location:** Select the menu location on the display screen.
- **Menu Timer:** Set the duration where the OSD menu stays visible on the screen.

Auto Source

Choose this option to let the projector automatically find an available input source.

Input Source

Select the input source between HDMI1, HDMI2, VGA, Video, and HOME.

Input Name

Use to rename the input function for easier identification. The available options include HDMI1, HDMI2, VGA, Video, and HOME.

USING THE PROJECTOR

High Altitude

When “On” is selected, the fans will spin faster. This feature is useful in high altitude areas where the air is thin.

Display Mode Lock

Choose “On” or “Off” to lock or unlock adjusting display mode settings.

Keypad Lock

When the keypad lock function is “On”, the Keypad will be locked. However, the projector can be operated by the remote control. By selecting “Off”, you will be able to reuse the Keypad.

Information Hide

Enable this function to hide the information message.

- **Off:** Choose “Off” to show the “searching” message.
- **On:** Choose “On” to hide the info message.

Logo

Use this function to set the desired startup screen. If changes are made, they will take effect the next time the projector is powered on.

- **Default:** The default startup screen.
- **Neutral:** Logo is not displayed on startup screen.
- **User:** Logo capture tool required.
Note: *Please visit the website to download the logo capture tool.
The supported file format: png/bmp/jpg.*

Background Color

Use this function to display a blue, red, green, gray color, none, or logo screen when no signal is available.

Note: *If the background color is set to “None”, then the background color is black.*

Reset OSD menu

Reset OSD

Return the OSD menu settings to factory default.

Reset to Default

Return all settings (including Android settings) to factory default.

USING THE PROJECTOR

Info menu

View the projector information as listed below:

- Regulatory
- Serial Number
- Source
- Resolution
- Refresh Rate
- Display Mode
- Power Mode (Standby)
- Light Source Hours
- Network Status
- IP Address
- Projector ID
- Brightness Mode
- FW Version

USING THE PROJECTOR

System settings menu

On the Home screen, select the system settings menu “” to configure various system settings.

General menu navigation

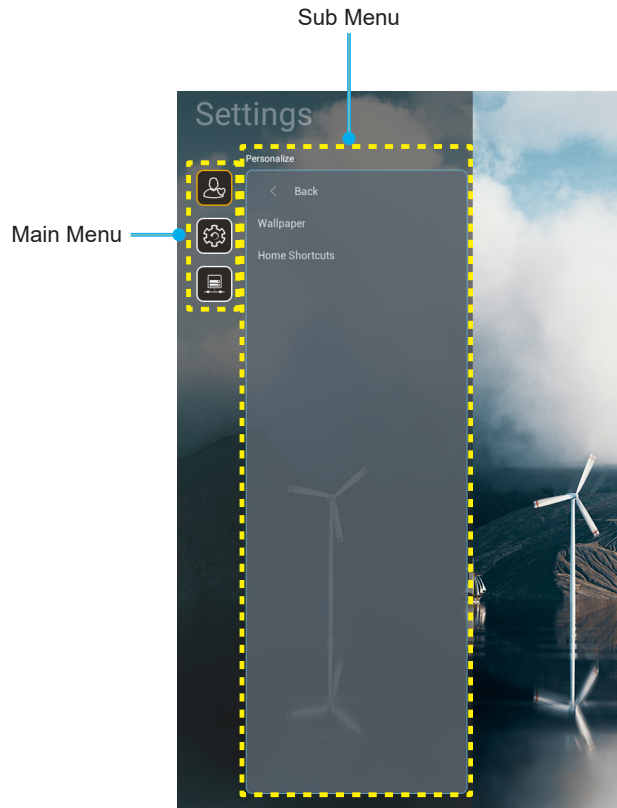

1. When the system settings menu is displayed, use the up and down navigation buttons to select any item in the main menu. While making a selection on a particular page, press the “**OK**” or the “**Right**” button on the remote control to enter the submenu.
2. Press the “**Left**” and “**Right**” button to select the desired menu item. Then press “**OK**” to open its sub menu.
3. Press the “**Up**” and “**Down**” button to select the desired item in the sub menu.
4. Press the “**OK**” or “**Right**” button to access the selected sub menu item settings.
5. Press the “**Up**”, “**Down**”, “**Left**”, or “**Right**” button to select the setting or press the “**Left**” and “**Right**” button to adjust the value (if necessary).
6. Press “**OK**” to confirm the setting.
7. Select the next item to be adjusted in the sub menu and modify as described above.
8. To exit, press “**↶**” (repeatedly if necessary). The settings menu will close and the projector will automatically save the new settings.

USING THE PROJECTOR

System settings menu tree

Level 1	Level 2	Level 3	Level 4	Value	
Personalize	Wallpaper	Optoma style...			
	Home Shortcuts	Shortcut1			
		Shortcut2			
		Shortcut3			
		Shortcut4			
		Shortcut5			
		Shortcut6			
System	Apps	Optoma Management Suite			
		File Manager			
		Optoma Marketplace			
		Creative Cast Pro			
		Lightning			
	Keyboard	Current keyboard			
		Manage keyboards	谷歌拼音输入法		OFF
			Kika Keyboard		ON
	Date and Time	Time Zone			
		Use 24-hour format	ON		
			OFF [Default]		
	System Update				
	Internal Storage				
Legal					
Control	Wireless	Wi-Fi	ON [Default]		
			OFF		
		Available Networks SSID (When WiFi On)			
		Add New Network			
	Portable Hotspot	Portable Wi-Fi Hotspot			
	Ethernet	Proxy Settings			
		IP settings			
		Reset			
OMS					

Note: Functions vary depending on model definition.

USING THE PROJECTOR

Personalize menu



Home Shortcuts

Review Home screen shortcuts of all opened apps in each input source. The items cannot repeat except for “Automatic” option which means the system will remember up to six latest apps that have been opened and then will replace app shortcuts so that the latest app will be the first app in the apps list while other apps in the list are shifted by one position.

USING THE PROJECTOR

System menu



Apps

Select the desired pre-installed app that you want to launch.

Keyboard

Configure the keyboard settings.

- **Current keyboard:** Indicate the current virtual keyboard used by the system.
- **Manage keyboards:** Turn on/off the input method app. If the app is turned on, the opened input method app will be displayed in the “**Current keyboard**” selection list.

Date and Time

Configure the date and time settings.

- **Time Zone:** Select the time zone in your location.
- **Use 24-hour format:** Set to “ON” to display time in 24-hour format. Set to “OFF” to display time in 12-hour format (AM/PM).

System Update

Follow the on-screen instructions to update the projector firmware.

Internal Storage

View the remaining internal storage space.

USING THE PROJECTOR

Legal

Review legal documents including “Terms and Conditions of Use”, “Privacy Policy”, and “Cookies Policy”.

Note: *You can review legal documents online as well. Please refer to the following web addresses:*

- *Terms and Conditions of Use*: <https://www.optoma.com/terms-conditions/> .
- *Cookies Policy*: <https://www.optoma.com/cookies-policy/> .
- *Privacy Policy*: <https://www.optoma.com/software-privacy-policy/> .
- *Open Source License*

USING THE PROJECTOR

Control menu



Wireless

Configure wireless network settings.

- **Wi-Fi:** Set the Wi-Fi option to “ON” to enable wireless network feature.
- **Available Network SSID:** Select your desired wireless access point and enter or configure the necessary connection parameters (if required), for example password, proxy settings, and IP address. For information, you can review the signal strength.
Choose “Cancel” to return to the Network menu without saving settings. Choose “Forget” to delete the wireless network profile.
Note: *Whenever you need to input symbols, the system will automatically pop-up an onscreen keyboard.*
- **Add New Network:** Manually enter the network name.
- **Portable Hotspot:** Configure the projector to behave as a wireless access point for other devices.

Ethernet

Configure wired network settings.

Note: *Make sure you have connected the projector to local area network (LAN). Please refer to page 16.*

- **Proxy Settings:** Provide proxy hostname, connection port and bypass proxy domains information manually if requested.
- **IP settings:** Enable DHCP if you want the projector to obtain IP address and other connection parameters automatically from your network. Disable DHCP if you want to assign IP address, gateway, network prefix length, and DNS parameters manually.
- **Reset:** Return the factory default settings for network settings.

OMS

Use this software to manage your devices remotely, including broadcasting emergency messages, real-time monitoring and alerts, and scheduling on/off time of the devices.

USING THE PROJECTOR

LAN/RJ45 function

For simplicity and ease of operation, the projector provides diverse networking and remote management features. The LAN / RJ45 uses network function to help remotely manage: Power On / Off, brightness, and contrast settings. You can also view the projector status information, such as: Video- Source, Sound-Mute, etc.

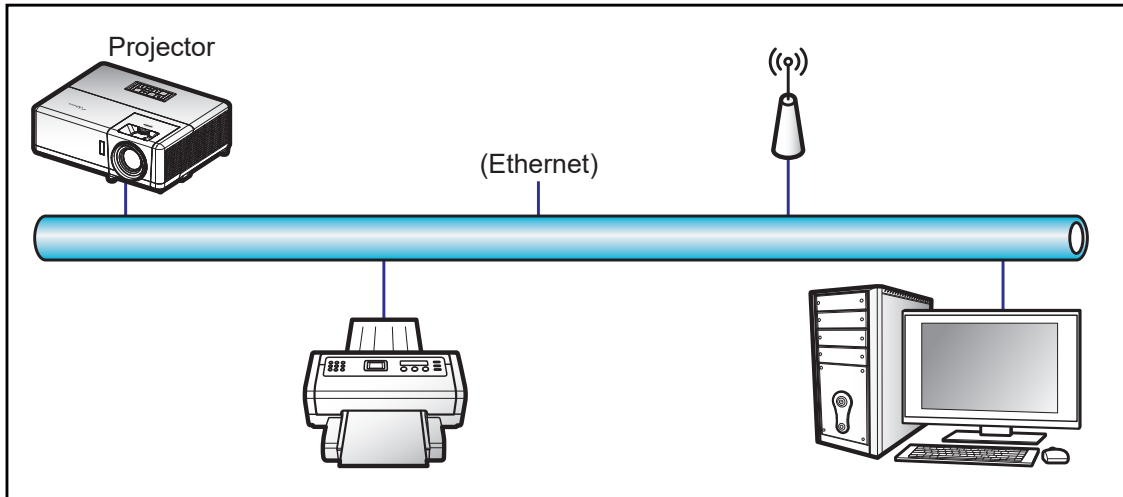

Wired LAN terminal functionalities

This projector can be controlled by using a PC (laptop) or other external device via LAN / RJ45 port and compatible with Crestron / Extron / AMX (Device -Discovery) / PJLink.

- Crestron is a registered trademark of Crestron Electronics, Inc. of the United States.
- Extron is a registered trademark of Extron Electronics, Inc. of the United States.
- AMX is a registered trademark of AMX LLC of the United States.
- PJLink applied for trademark and logo registration in Japan, the United States of America, and other countries by JBMIA.

The projector is supported by the specified commands of the Crestron Electronics controller and related software, for example RoomView®.

<http://www.crestron.com/>

This projector is compliant to support Extron device(s) for reference.

<http://www.extron.com/>

This projector is supported by AMX (Device Discovery).

<http://www.amx.com/>

This projector supports all commands of PJLink Class2.

<http://pjlink.jbmia.or.jp/english/>

For more detailed information about the various types of external devices which can be connected to the LAN / RJ45 port and remote control the projector, as well as the supported commands for these external devices, please contact the Support-Service directly.

USING THE PROJECTOR

Ethernet (Projector settings)

1. Power on the projector.
2. Connect an RJ45 cable to RJ45 ports on the projector and the PC (laptop).

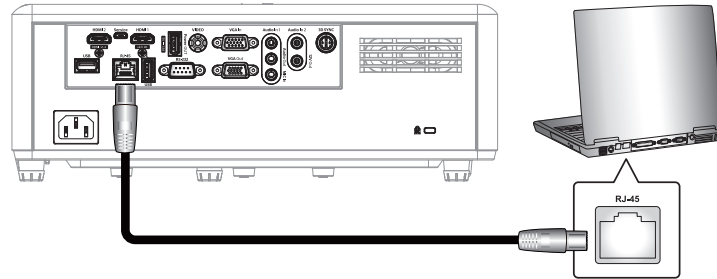

3. Follow the on-screen instructions to configure the network settings.
(Projector Home Screen > **Settings** > **Control** > **Ethernet** > **IP Settings** > **Static**)

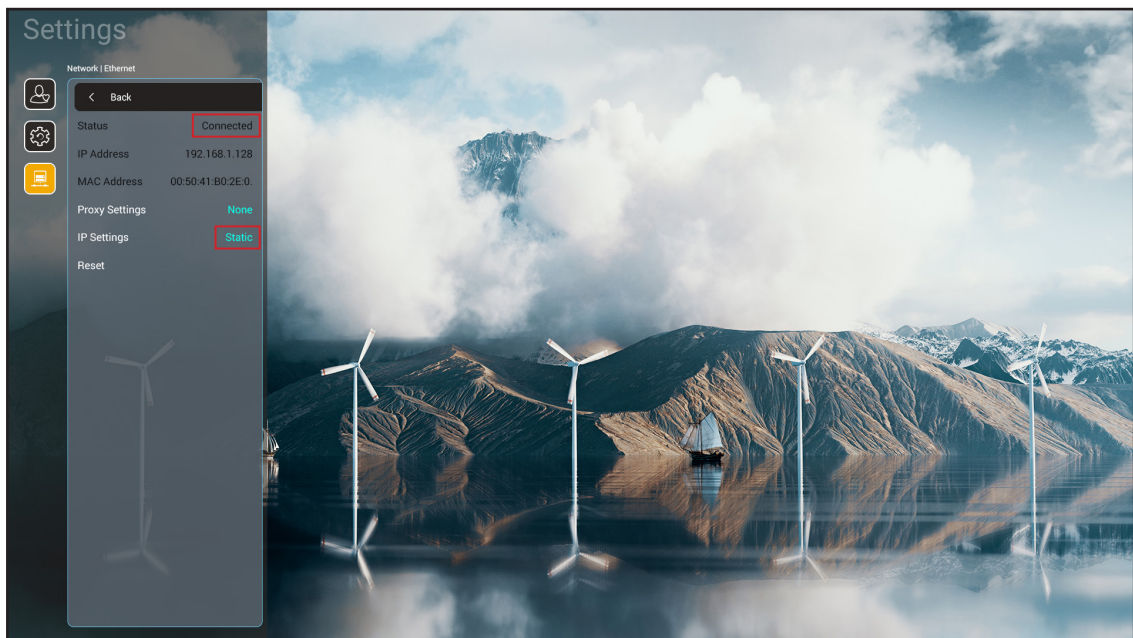

Note: After the network configuration is complete, the Status will show “Connected”.

USING THE PROJECTOR

PC settings

1. Connect an RJ45 cable to RJ45 ports on the projector and the PC (laptop).

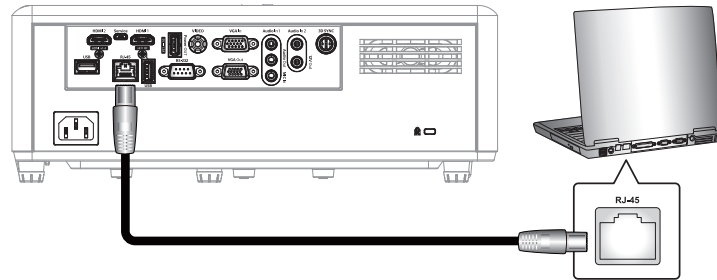

2. On the PC (Laptop), select **Start > Control Panel > Network Connections**.

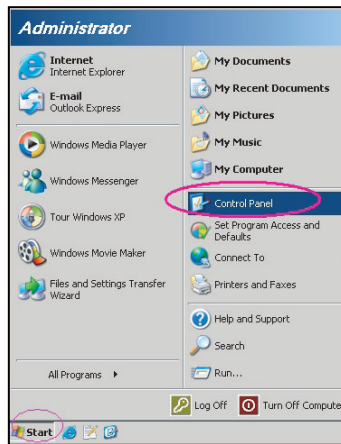

3. Right-click on the **Local Area Connection**, and select **Property**.

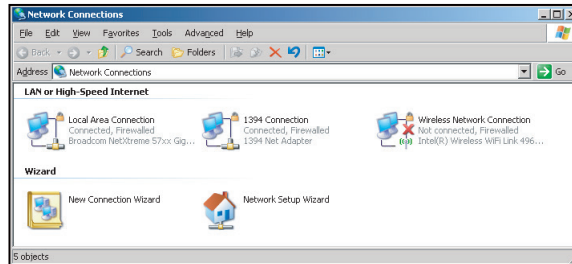

4. In the **Properties** window, select the **General** tab, and select **Internet Protocol (TCP / IP)**.

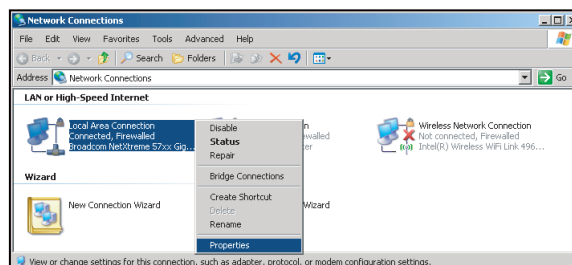

USING THE PROJECTOR

5. Click “Properties”.

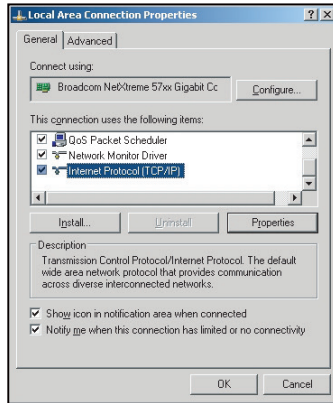

6. Type in the IP address and Subnet mask, then press “OK”.

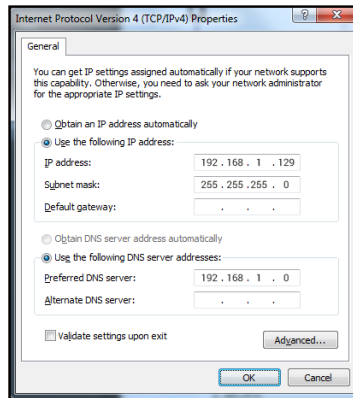

7. Open a web browser, for example Microsoft Edge or Google Chrome.
 8. In the Address bar, input the projector’s IP address: 192.168.1.128 : 8088.
 9. Press “Enter”.
- The projector is setup for remote management. The LAN / RJ45 function displays as follows:

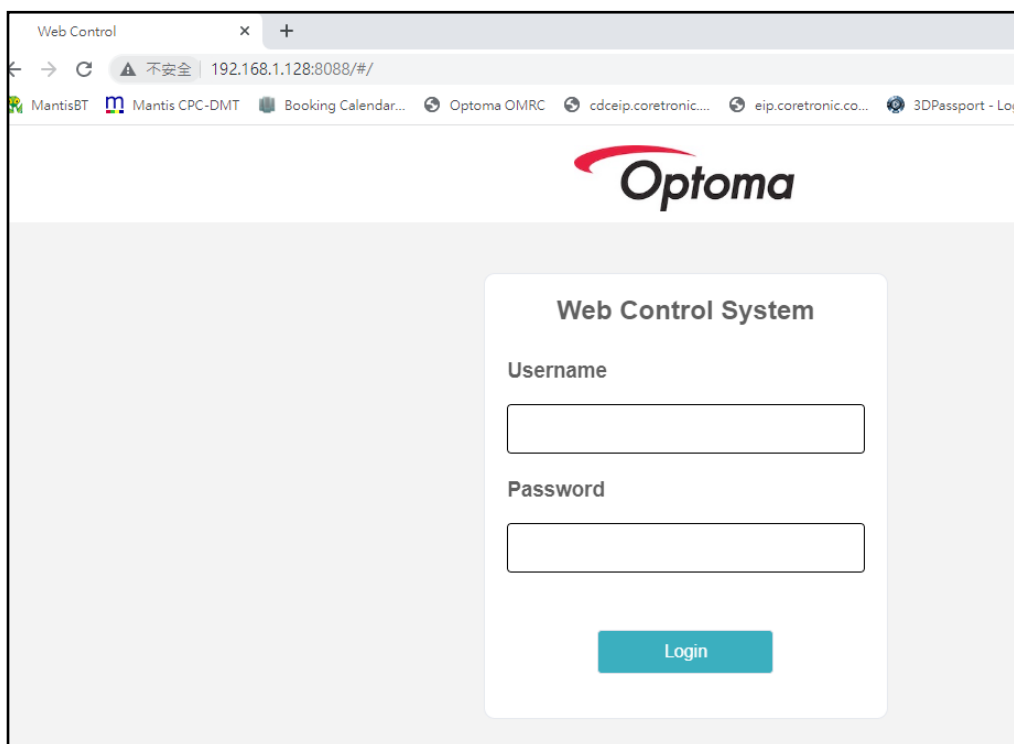

USING THE PROJECTOR

Login and configuration for network control

1. Login to the projector from the web browser (e.g., 192.168.1.128 : 8088 and press “Enter”).
 - Username: admin
 - Password: admin

Note: Password should be changed when logging in for the first time.

The screenshot shows the Optoma web interface. On the left is a dark sidebar with the following menu items: Administrator, Projector Control, Alert Setup, Network Setup, Information, Crestron V2, and Logout. The main content area is split into two panels. The left panel, titled 'Projector Information', contains two text input fields: 'Projector Name' with the value 'DAZHUZT+' and 'Projector ID' with the value '0'. A blue 'Save' button is positioned below these fields. The right panel, titled 'Change Password', contains three text input fields: 'Old Password', 'New Password', and 'Confirm New Password', each with a placeholder 'please input...'. A blue 'Save' button is located at the bottom of this panel.

2. Click **General**. Then, in **Power Setting**, set the **Power Mode** setting to **Active**.

The screenshot shows the Optoma web interface with the 'General' menu item selected in the sidebar. The main content area is divided into three sections. The 'General Control' section on the left includes: 'Power' with a blue toggle switch set to 'ON'; 'Resync' with a blue button; 'Reset OSD' with a blue button; 'AV Mute' with a toggle switch set to 'OFF'; 'Freeze' with a toggle switch set to 'OFF'; and 'High Altitude' with a toggle switch set to 'OFF'. The 'Volume Setting' section on the right includes: 'Mute' with a toggle switch set to 'OFF'; and 'Volume' with a slider set to 5. The 'Power Setting' section on the right includes: 'Power Mode' with a dropdown menu showing 'Active' (highlighted with a red box); and 'Brightness Mode' with a dropdown menu showing 'Constant Power 100%'.

USING THE PROJECTOR

3. Click **Network Setup** and turn on the function button you would like to work.

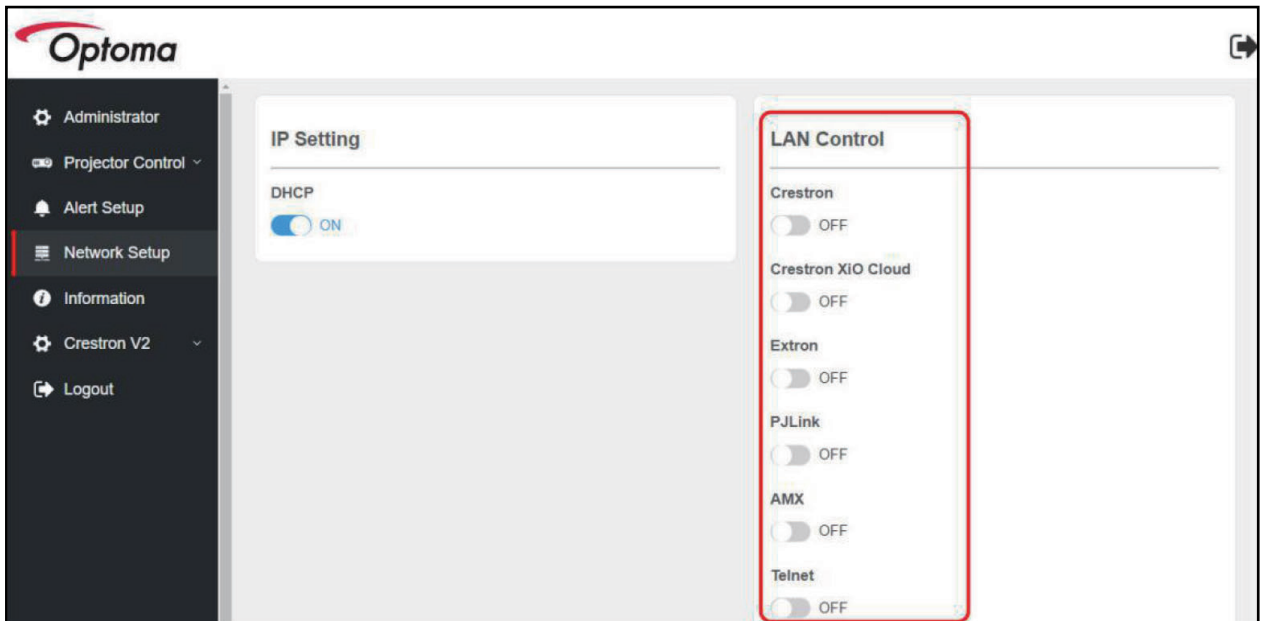

Note:

Crestron	Port: 41794
PJ-Link	Port: 4352
AMX	Port: 9131
Telnet	Port: 23
Webpage control	Port: 8088
Optoma Web Server	Port: 8080
Creative Cast App	Port: 80
Extron	Port: 2023

USING THE PROJECTOR

Crestron

1. On the Projector “Control” settings or via Browser LAN Control webpage, switch the **Crestron** function to **ON**.

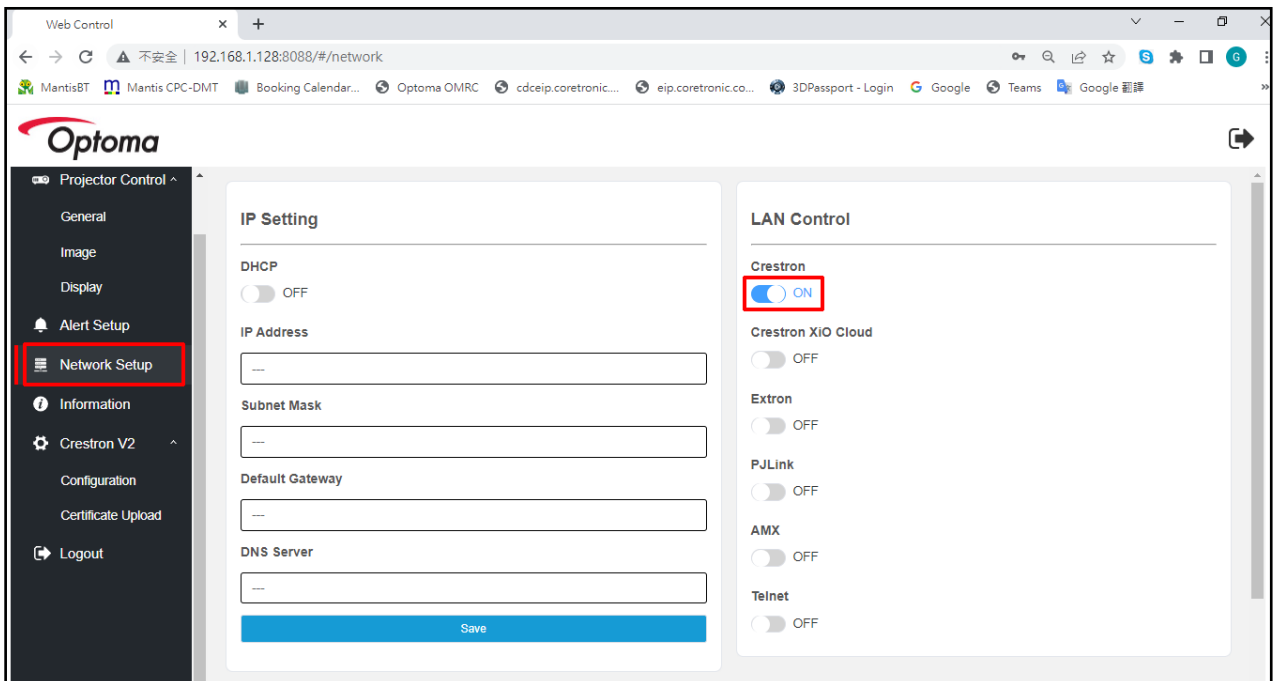

USING THE PROJECTOR

2. Switch to “Crestron Certificate Upload” page to upload the certificate.

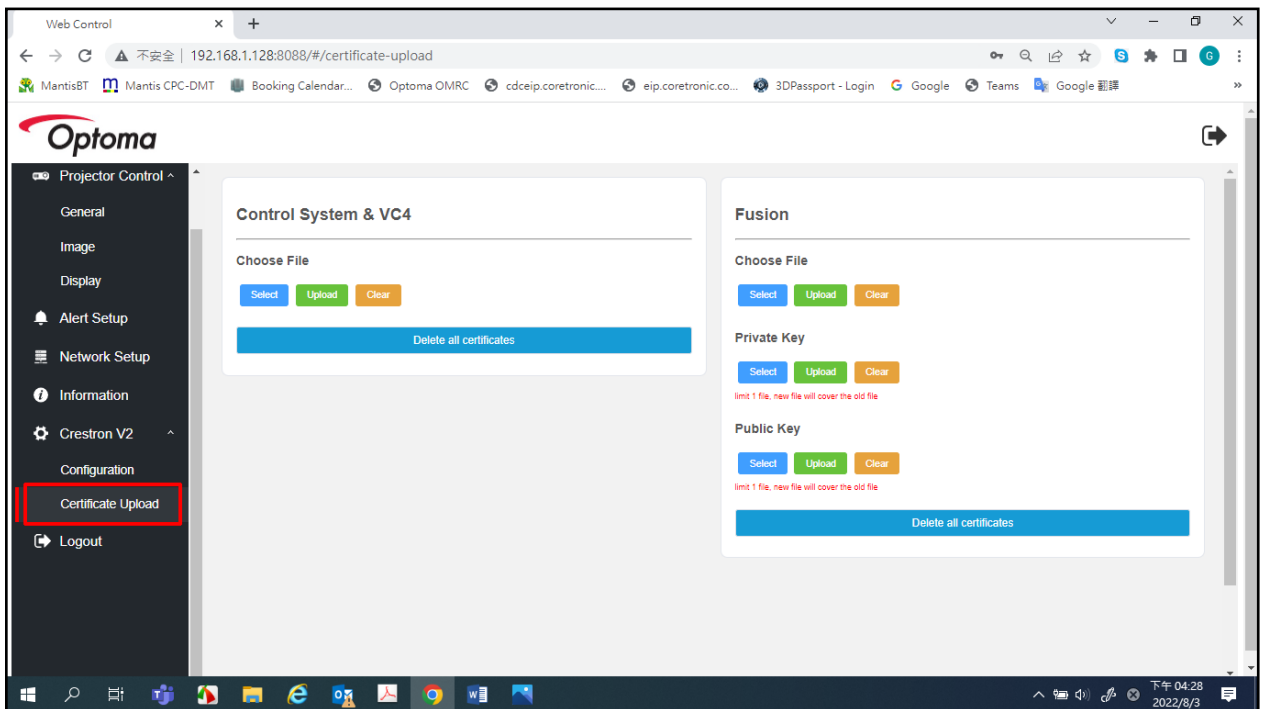

3. Select the desired Crestron's function and configure the necessary settings.

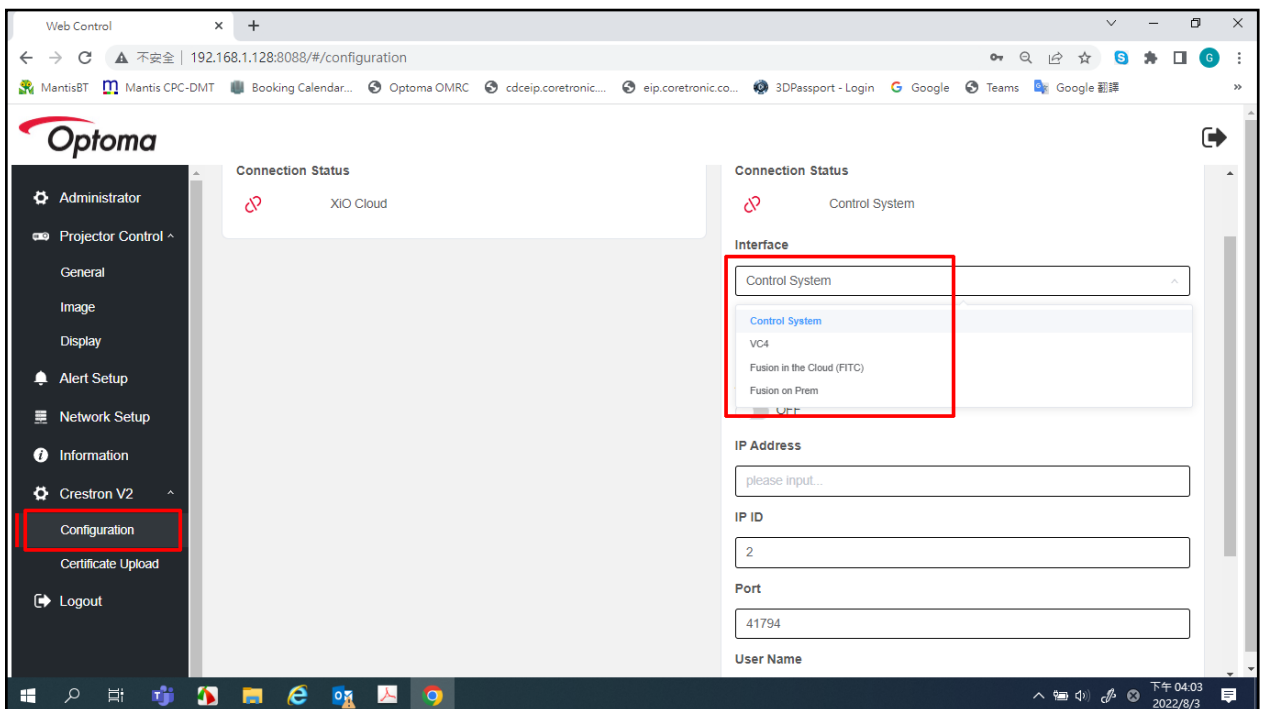



USING THE PROJECTOR

Selecting an input source

You can select any input source directly on the Home screen using an input shortcut.

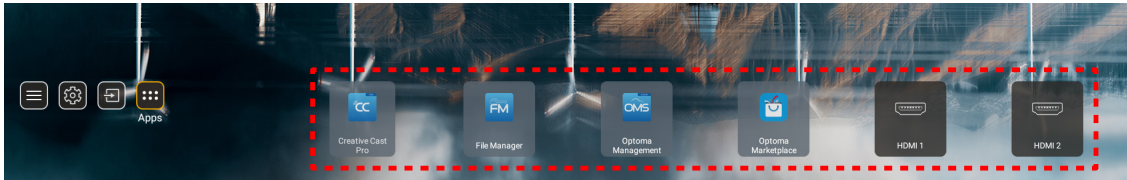
Note: You can personalize shortcut settings in “System Settings menu → Personalize → Home Shortcuts”. You can also modify the shortcut order on the Home screen.



If the desired input source is not visible on the Home screen, select “” to view all input options. Then select your input source or select “Home” to return to the Home screen.

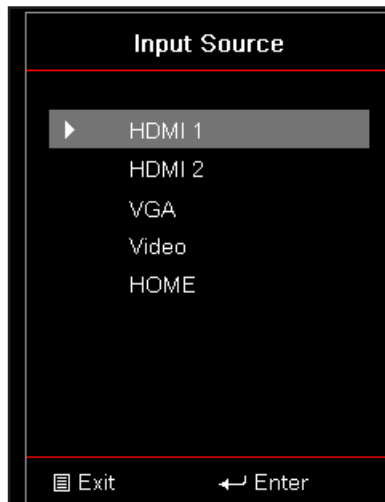

USING THE PROJECTOR

Selecting an app

You can select any app directly on the Home screen using an app shortcut.

Note: You can personalize shortcut settings in “System Settings menu → Personalize → Home Shortcuts”.

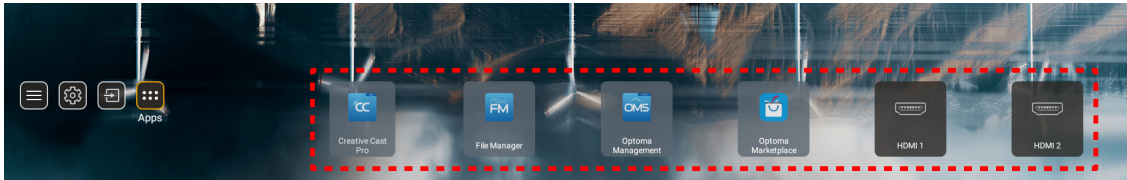

If the desired app is not visible on the Home screen, select “” to view all installed apps. Then select your desired app.



USING THE PROJECTOR

Creative Cast

To get the App, you can do either of the following:

- if you are using a mobile device, scan the QR code on the screen.
- if you are using a computer, simply go to the link.

Then install the Creative Cast app on your computer or mobile device.

Before you get started, make sure to connect your computer or mobile device to the same network as the projector. Then follow the on-screen instructions to operate the App.



Note: For initial activation of the iOS screen mirroring function, please ensure the projector is connected to the internet, then launch the Creative Cast app. You are only required to perform this initial step once and after the initial connection is established, the Creative Cast app does not need to be open for future use of the iOS screen mirroring function.

USING THE PROJECTOR

Optoma Marketplace

With the Optoma Marketplace app, you can search and install any App.

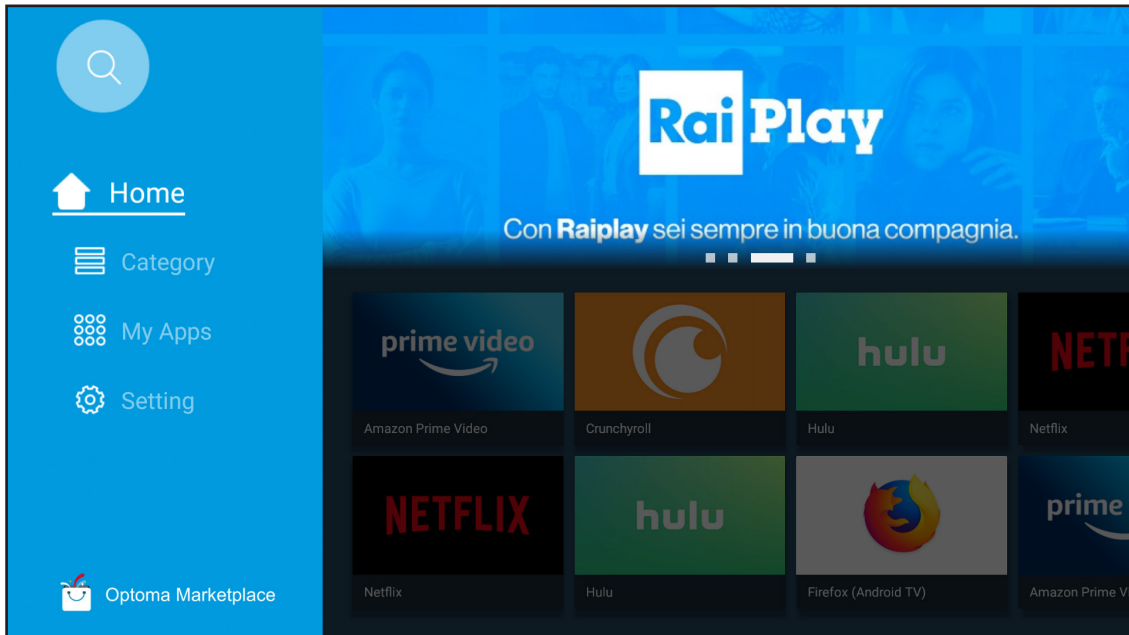

File Manager

With the File Manager app, you can manage the files stored in the internal storage, external storage, and cloud storage.

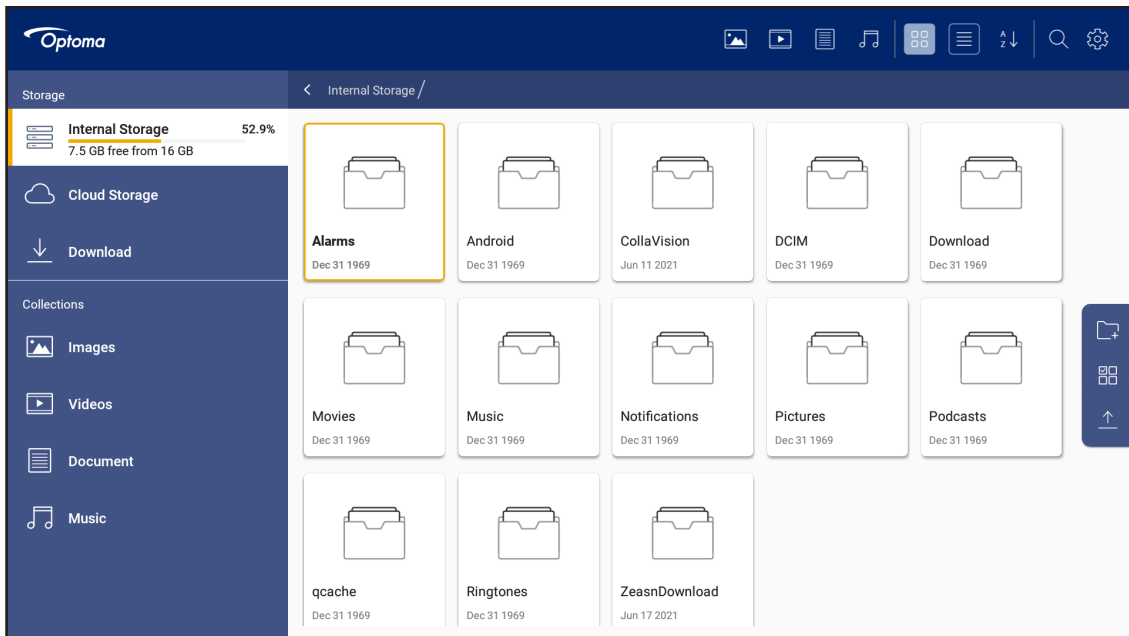

USING THE PROJECTOR

Optoma Management Suite (OMS)

Follow the on-screen instructions to set up and use it.



USING THE PROJECTOR

Supported multimedia formats

If you want to play multimedia files, connect a USB storage with multimedia content to the projector. Then open the multimedia player app and select the desired files to play.

The projector supports the following multimedia formats:

Audio Format

Decoder	Supported Format
MPEG	MP1, MP2, MP3
OGG	OGG, OGA
FLAC	FLACC
AAC	AAC, M4A

Video Format

Decoder	Supported Format
MPEG-1/2	DAT, MPG, VOB, TS
H.264/AVC	AVI, MKV, MP4, MOV, 3GP, TS, FLV
MOTION JPEG	AVI

Photo Format

Decoder	Supported Format
JPEG	JPG, JPEG
BMP	BMP
GIF	GIF
PNG	PNG
WEBP	WEBP

Office Viewer

Document Format	Supported Version and Format
PDF	PDF 1.7 and above(*.pdf)
Writer (Word)	Microsoft Word 97/2000/XP/2003 Document(*.doc)
	Microsoft Word 97/2000/XP/2003 Template(*.dot)
	Microsoft Word 2007/2010 Document(*.docx)
	Microsoft Word 2007/2010 Template(*.dotx)
	Text Files(*.txt, *.log)
Spreadsheet (Excel)	Microsoft Excel 97/2000/XP/2003 Workbook(*.xls)
	Microsoft Excel 2007/2010 Workbook(*.xlsx)
	Text Files(*.csv)
	Microsoft Excel 97/2000/XP/2003 Template(*.xlt)
	Microsoft Excel 2007/2010 Template(*.xltx)
Presentation (PowerPoint)	Microsoft PowerPoint 97/2000/XP/2003 Presentation(*.ppt, *.pps)
	Microsoft PowerPoint 2007/2010 Presentation(*.pptx, *.ppsx)
	Microsoft PowerPoint 97/2000/XP/2003 Presentation Templates(*.pot)
	Microsoft PowerPoint 2007/2010 Presentation Templates(*.potx)

USB Supported Format

FAT32
NTFS
exFAT

USING THE PROJECTOR

Viewing the status bar

By default, the Status Bar on the Home screen contains icons indicating connection status regarding wired network, USB, and wireless network. You can select any of the icons to open the associated menu. Selecting wired or wireless status icon results in opening the network configuration menu, while selecting the USB status icon results in opening the browser and displaying the content of the connected USB device.

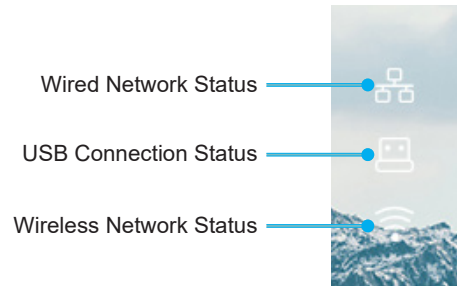

ADDITIONAL INFORMATION

Compatible resolutions

NTSC	NTSC M/J, 3.58MHz, 4.43MHz
PAL	PAL B/D/G/H/I/M/N, 4.43MHz
SECAM	SECAM B/D/G/K/K1/L, 4.25/4.4 MHz
SDTV	480i/p, 576i/p
HDTV	720p(50/60Hz), 1080i(50/60Hz), 1080P(50/60Hz)

Video Timing

Signal	Resolution	Refresh Rate(Hz)	Notes
TV(NTSC)	720 X 480	60	For Composite Video /S-video
TV(PAL,SECAM)	720 X 576	50	
SDTV(480I)	720 X 480	60	For Component
SDTV(480P)	720 X 480	60	
SDTV(576I)	720 X 576	50	
SDTV(576P)	720 X 576	50	
HDTV(720p)	1280 X 720	50/60	
HDTV(1080I)	1920 X1080	50/60	
HDTV(1080p)	1920 X1080	24/50/60	

True 3D video compatibility

Input Resolutions	HDMI 1.4a 3D Input	Input timing		
		1280 x 720P @ 50Hz	Top-and-Bottom	
		1280 x 720P @ 60Hz	Top-and-Bottom	
		1280 x 720P @ 50Hz	Frame packing	
		1280 x 720P @ 60Hz	Frame packing	
		1920 x 1080i @ 50Hz	Side-by-Side(Half)	
		1920 x 1080i @ 60Hz	Side-by-Side(Half)	
		1920 x 1080P @ 24Hz	Top-and-Bottom	
		1920 x 1080P @ 24Hz	Frame packing	
	HDMI 1.3	1920 x 1080i @ 50Hz	Side-by-Side(Half)	SBS mode is on
		1920 x 1080i @ 60Hz		
		1280 x 720P @ 50Hz		
		1280 x 720P @ 60Hz		
		800 x 600 @ 60Hz		
		1024 x 768 @ 60Hz		
		1280 x 800 @ 60Hz		
		1920 x 1080i @ 50Hz	Top-and-Bottom	TAB mode is on
		1920 x 1080i @ 60Hz		
		1280 x 720P @ 50Hz		
		1280 x 720P @ 60Hz		
		800 x 600 @ 60Hz		
		1024 x 768 @ 60Hz		
		1280 x 800 @ 60Hz		
	480i	HQFS	3D format is Frame sequential	

Note:

- If 3D input is 1080p@24Hz, the DMD should replay with integral multiple with 3D mode.

ADDITIONAL INFORMATION

- Support NVIDIA 3DTV Play if there is no patent fee from Optoma.
- 1080i@25Hz and 720p@50Hz will run in 100Hz; 1080p@24Hz will run in 144Hz; other 3D timing will run in 120Hz.

Computer Compatibility

VESA standards Computer Signal (Analog RGB Compatible)

Signal	Resolution	Refresh Rate(Hz)	Notes
VGA	640 X 480	60/67/72/85	Mac 60/72/85
SVGA	800 X 600	56/60(*2)/72/85/120(*2)	Mac 60/72/85
XGA	1024 X768	48/50(*4)/60(*2)/70/75/85/120(*2)	Mac 60/70/75/85
HDTV(720P)	1280 X 720	50/60(*2)/120(*2)	Mac 60
WXGA	1280 X768	60/75/85	Mac 60/75/85
	1280 X800	48/50(*4)60	Mac 60
WXGA(*3)	1366 X768	60	
SXGA	1280 X1024	60/75/85	Mac 60/75
SXGA+	1400 X1050	60	
UXGA	1600 X 1200	60	
HDTV(1080p)	1920 X1080	24/50/60	Mac 60
WUXGA	1920 X1200(*1)	60/50hz(*4)	Mac 60

Note:

- (*1)1920 x 1200 @60Hz only support RB(reduced blanking).
- (*2) Support 3D timing for 3D Ready projector (STD) and True 3D projector (Optional).
- (*3) Windows 8 standard timing.
- (*4) Proscene and Data Projector > 4,000L only, Native resolution must support @50Hz.

Input Signal for HDMI/DVI-D

Signal	Resolution	Refresh Rate(Hz)	Notes
VGA	640 X 480	60	Mac 60/72/85
SVGA	800 X 600	60(*2)/72/85/120(*2)	Mac 60/72/85
XGA	1024 X768	48/50(*4)/60(*2)/70/75/85/120(*2)	Mac 60/70/75/85
SDTV(480I)	720 X 480	60	
SDTV(480P)	720 X 480	60	
SDTV(576I)	720 X 576	50	
SDTV(576P)	720 X 576	50	
WSVGA(1024X600)	1024 X 600	60 (*3)	
HDTV(720p)	1280 X 720	50(*2)/60/120(*2)	Mac 60
WXGA	1280 X768	60/75/85	Mac 75
	1280 X800	60/50/48hz(*4)	Mac 60
WXGA(*5)	1366X768	60	
SXGA	1280 X1024	60/75/85	Mac 60/75
	1440 x 900	60	
SXGA+	1400 X1050	60	
UXGA	1600 X 1200	60	
HDTV(1080I)	1920 X1080	50/60	
HDTV(1080p)	1920 X1080	24/30/50/60	Mac 60

ADDITIONAL INFORMATION

Signal	Resolution	Refresh Rate(Hz)	Notes
WUXGA	1920 X1200(*1)	60/50(*4)	Mac 60

Note:

- (*1) 1920 x 1200 @60Hz only support RB(reduced blanking).
- (*2) Support 3D timing for 3D Ready projector (STD) and True 3D projector (Optional).
- (*3) New ERA & Data projector must have this timing WSVGA, Proscene and Home is nice to have.
- (*4) Proscene and Data Projector > 4,000L only, Native resolution must support @50Hz/48Hz.
- (*5) Windows 8 standard timing.

HDMI 1.4

B0/Established Timing		
Resolution	V [Hz]	H [Hz]
720x400	70.0	31.5
640x480	60.0	31.5
640x480	66.6(67)	34.9
640x480	72.0	37.9
640x480	75.0	37.5
800x600	56.0	35.1
800x600	60.0	37.9
800x600	72.0	48.1
800x600	75.0	46.9
832x624	75.0	49.1
1024x768	60.0	48.4
1024x768	70.0	56.5
1024x768	75.0	60.0
1280x1024	75.0	80.0
1152x870	75.0	68.7

B0/Standard Timing (1080P/WUXGA)			
Resolution	V [Hz]	H [Hz]	Aspect Ratio
1280x720	60.0	-	16:09
1280x800	60.0	-	16:10
1280x1024	60.0	-	5:04
640x480	120.0	-	4:03
800x600	120.0	-	4:03
1024x768	120.0	-	4:03
1280x800	120.0	-	16:10
1920x1200	60.00	-	16:10

B0/Detail Timing (1080P)		
Resolution	V [Hz]	H [Hz]
1920x1080	60.0	37.9

B1/Video Mode		
VIC	Resolution	V [Hz]
1	640x480p 4:3	60.0
2	720x480p 4:3	60.0
3	720x480p 16:9	60.0

ADDITIONAL INFORMATION

B1/Video Mode		
VIC	Resolution	V [Hz]
4	1280x720p 16:9	60.0
5	1920x1080i 16:9	60.0
6	720(1440)x480i 4:3	60.0
7	720(1440)x480i 16:9	60.0
16	1920x1080p 16:9	60.0
17	720x576p 4:3	50.0
18	720x576p 16:9	50.0
19	1280x720p 16:9	50.0
20	1920x1080i 16:9	50.0
21	720(1440)x576i 4:3	50.0
22	720(1440)x576i 16:9	50.0
31	1920x1080p 16:9	50.0
32	1920x1080p 16:9	24.0
34	1920x1080p 16:9	30.0
93	3840 x 2160p 16:9	24.00
94	3840 x 2160p 16:9	25.00
95	3840 x 2160p 16:9	30.00
98	4096 x 2160p 256:135	24.00
99	4096 x 2160p 256:135	25.00
100	4096 x 2160p 256:135	30.00

B1/Detail Timing	
Resolution	V [Hz]
1920 x 1080	60.00
1366 x 768	60.00
1920 x 1200	60.00

HDMI 2.0

B0/Established Timing		
Resolution	V [Hz]	H [Hz]
720x400	70.0	31.5
640x480	60.0	31.5
640x480	66.6(67)	34.9
640x480	72.0	37.9
640x480	75.0	37.5
800x600	56.0	35.1
800x600	60.0	37.9
800x600	72.0	48.1
800x600	75.0	46.9
832x624	75.0	49.1
1024x768	60.0	48.4
1024x768	70.0	56.5
1024x768	75.0	60.0
1280x1024	75.0	80.0
1152x870	75.0	68.7

ADDITIONAL INFORMATION

B0/Standard Timing (1080P)			
Resolution	V [Hz]	H [Hz]	Aspect Ratio
1280x720	60.0	-	16:09
1280x800	60.0	-	16:10
1280x1024	60.0	-	5:04
640x480	120.0	-	4:03
800x600	120.0	-	4:03
1024x768	120.0	-	4:03
1280x800	120.0	-	16:10
1920x1200	60.00	-	16:10

B0/Detail Timing (1080P)		
Resolution	V [Hz]	H [Hz]
1920x1080	60.0	67.5

B1/Video Mode		
VIC	Resolution	V [Hz]
1	640x480p 4:3	60.0
2	720x480p 4:3	60.0
3	720x480p 16:9	60.0
4	1280x720p 16:9	60.0
5	1920x1080i 16:9	60.0
6	720(1440)x480i 4:3	60.0
7	720(1440)x480i 16:9	60.0
16	1920x1080p 16:9	60.0
17	720x576p 4:3	50.0
18	720x576p 16:9	50.0
19	1280x720p 16:9	50.0
20	1920x1080i 16:9	50.0
21	720(1440)x576i 4:3	50.0
22	720(1440)x576i 16:9	50.0
31	1920x1080p 16:9	50.0
32	1920x1080p 16:9	24.0
34	1920x1080p 16:9	30.0
93	3840 x 2160p 16:9	24.00
94	3840 x 2160p 16:9	25.00
95	3840 x 2160p 16:9	30.00
96	3840 x 2160p 16:9	50.00
97	3840 x 2160p 16:9	60.00
98	4096 x 2160p 256:135	24.00
99	4096 x 2160p 256:135	25.00
100	4096 x 2160p 256:135	30.00
101	4096 x 2160p 256:135	50.00
102	4096 x 2160p 256:135	60.00

B1/Detail Timing	
Resolution	V [Hz]
1920 x 1080	60.00

ADDITIONAL INFORMATION

B1/Detail Timing	
Resolution	V [Hz]
1366 x 768	60.00

Analog

B0/Established Timing		
Resolution	V [Hz]	H [Hz]
720x400	70.0	31.5
640x480	60.0	31.5
640x480	66.6(67)	34.9
640x480	72.0	37.9
640x480	75.0	37.5
800x600	56.0	35.1
800x600	60.0	37.9
800x600	72.0	48.1
800x600	75.0	46.9
832x624	75.0	49.1
1024x768	60.0	48.4
1024x768	70.0	56.5
1024x768	75.0	60.0
1280x1024	75.0	80.0
1152x870	75.0	68.7

B0/Standard Timing			
Resolution	V [Hz]	H [Hz]	Aspect Ratio
800x600	120.0	-	4:03
1024x768	120.0	-	4:03
1280x800	60.0	-	16:10
1280x1024	60.0	-	5:04
1280x720	60.0	-	16:09
640x480	120.0	-	4:03

B0/Detail Timing		
Resolution	V [Hz]	H [Hz]
1920x1080	60.0	67.5

B1/Detail Timing	
Resolution	V [Hz]
1366x768	60.0
1280x800	120.0
1920x1200	60.0

ADDITIONAL INFORMATION

Image size and projection distance

Diagonal Length Size of (16:9) Screen	Screen Size (W x H)				Projection Distance (D)				Offset (Hd)		Offset (Hd)	
	(m)		(inch)		(m)		(feet)		(m) max.	(inch) max.	(m) min.	(inch) min.
	Width	Height	Width	Height	Wide	Tele	Wide	Tele				
20.2	0.45	0.25	17.61	9.9	NA	1.0	NA	3.28	0.04	1.57	0.00	0.00
40	0.89	0.5	34.86	19.6	1.2	2.0	3.94	6.56	0.08	3.15	0.00	0.00
50	1.11	0.62	43.58	24.5	1.6	2.5	5.25	8.20	0.10	3.94	0.00	0.00
60	1.33	0.75	52.29	29.4	1.9	3.0	6.23	9.84	0.12	4.72	0.00	0.00
70	1.55	0.87	61.01	34.3	2.2	3.5	7.22	11.48	0.14	5.51	0.00	0.00
80	1.77	1	69.73	39.2	2.5	4.0	8.20	13.12	0.16	6.30	0.00	0.00
90	1.99	1.12	78.44	44.1	2.8	4.5	9.19	14.76	0.18	7.09	0.00	0.00
100	2.21	1.25	87.16	49	3.1	5.0	10.17	16.40	0.19	7.48	0.00	0.00
120	2.66	1.49	104.59	58.8	3.7	6.0	12.14	19.69	0.24	9.45	0.00	0.00
150	3.32	1.87	130.74	73.5	4.7	7.4	15.42	24.28	0.30	11.81	0.00	0.00
180	3.98	2.24	156.88	88.2	5.6	8.9	18.37	29.20	0.36	14.17	0.00	0.00
200	4.43	2.49	174.32	98.1	6.2	9.9	20.34	32.48	0.40	15.75	0.00	0.00
250	5.53	3.11	217.89	122.6	7.8	NA	25.59	NA	0.50	19.69	0.00	0.00
320.4	7.09	3.99	279.25	157.1	10.0	NA	32.81	NA	0.64	25.20	0.00	0.00

Note: Zoom Ratio: 1.6x

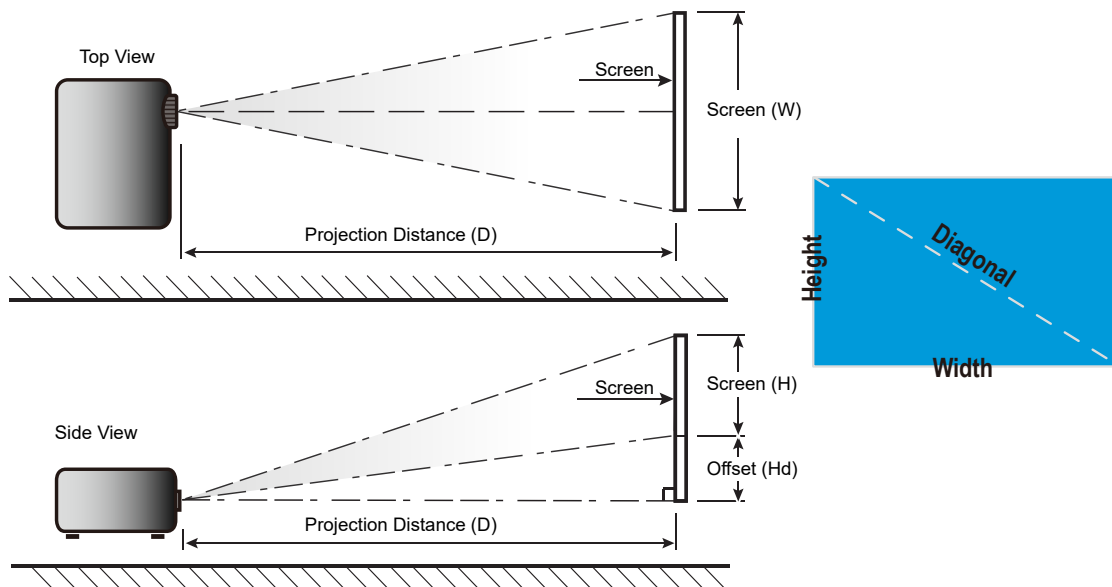

ADDITIONAL INFORMATION

Projector dimensions and ceiling mount installation

1. To prevent damage to your projector, please use an appropriate Optoma ceiling mount.
2. If you wish to use a third party ceiling mount kit, please ensure the screws used to attach a mount to the projector meet the following specifications:
 - Screw type: M4*0.7P*10mm
 - Minimum screw length: 10mm

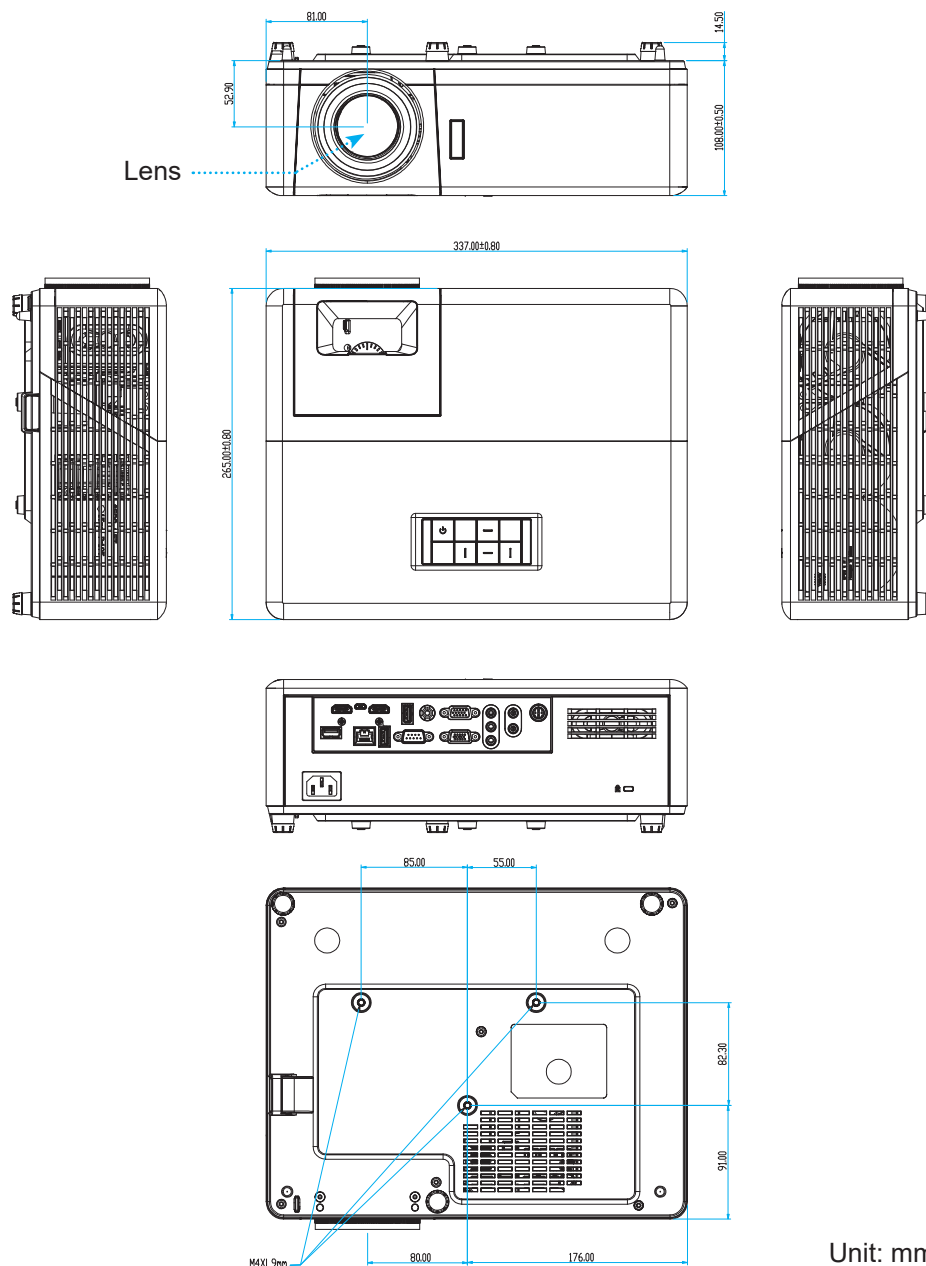

Unit: mm

Note: Please note that damage resulting from incorrect installation will void the warranty.



Warning:

- If you buy a ceiling mount from another company, please be sure to use the correct screw size. Screw size will vary depending on the thickness of the mounting plate.
- Be sure to keep at least 10 cm gap between the ceiling and the bottom of the projector.
- Avoid installing the projector near a heat source.

ADDITIONAL INFORMATION

IR remote codes









Key	Key num	MTX.	Format	Data0	Data1	Data2	Data3	Description	
Power on / off		K12	04	F1	32	CD	71	8E	Refer to the "Powering on / off the projector" on page 22.
Source		K3	11	F1	32	CD	18	E7	Press to select an input signal.
Home		K13	03	F1	32	CD	92	6D	Press to return to the Home screen.
Menu		K8	17	F1	32	CD	0E	F1	Press to launch the on-screen display (OSD) menu. To exit OSD, press again.
Return		K4	10	F1	32	CD	86	79	Press to return to the previous page.
Up		K7	18	F2	32	CD	11	EE	Use to select items or make adjustments to your selection.
Left		K14	02	F2	32	CD	10	EF	
Right		K5	09	F2	32	CD	12	ED	
Down		K2	19	F2	32	CD	14	EB	
Enter	Enter	K9	16	F1	32	CD	0F	F0	Confirm your item selection.
Mute		K15	01	F1	32	CD	52	AD	Press to turn off/on the projector built-in speaker.
Display Mode		K10	15	F1	32	CD	91	6E	Press to display the Display Mode menu. To exit the Display Mode menu, press again.
APP menu		K6	08	F1	32	CD	25	DA	Press to open the APP menu.
Volume -		K11	12	F2	32	CD	0C	F3	Press to decrease the volume.
Volume +		K1	05	F2	32	CD	09	F6	Press to increase the volume.

ADDITIONAL INFORMATION

Troubleshooting

If you experience a problem with your projector, please refer to the following information. If a problem persists, please contact your local reseller or service center.

Image problems

-  *No image appears on-screen*
- Ensure all the cables and power connections are correctly and securely connected as described in the "Installation" section.
 - Ensure the pins of connectors are not crooked or broken.
 - Ensure that the "Mute" feature is not turned on.
-  *Image is out of focus*
- Turn the focus ring clockwise or counterclockwise until the image is sharp and legible. (Please see page 17).
 - Make sure the projection screen is between the required distance from the projector. (Please refer to page 73).
-  *The image is stretched when displaying 16:9 DVD title*
- When you play anamorphic DVD or 16:9 DVD, the projector will show the best image in 16: 9 format on projector side.
 - If you play the V-Stretch format DVD title, please change the format as V-Stretch in projector OSD.
 - If you play 4:3 format DVD title, please change the format as 4:3 in projector OSD.
 - Please setup the display format as 16:9 (wide) aspect ratio type on your DVD player.
-  *Image is too small or too large*
- Turn the zoom lever clockwise or counterclockwise to increase or decrease the projected image size. (Please see page 17).
 - Move the projector closer to or further from the screen.
 - Press "Menu" on the projector panel, go to "Display → Aspect Ratio". Try the different settings.
-  *Image has slanted sides:*
- If possible, reposition the projector so that it is centered on the screen and below the bottom of the screen.
-  *Image is reversed*
- Select "Setup → Projection" from the OSD and adjust the projection direction.

ADDITIONAL INFORMATION

Other problems



The projector stops responding to all controls

- If possible, turn off the projector, then unplug the power cord and wait at least 20 seconds before reconnecting power.

Remote control problems



If the remote control does not work

- Check the operating angle of the remote control is pointed within $\pm 15^\circ$ (horizontally) or $\pm 10^\circ$ (vertically) to the IR receiver on the projector.
- Make sure there are not any obstructions between the remote control and the projector. Move to within 12 m (39.4 ft) of the projector.
- Make sure batteries are inserted correctly.
- Replace batteries if they are exhausted.

ADDITIONAL INFORMATION

Warning indicators

When the warning indicators (see below) light up or flash, the projector will automatically shutdown:

- “Lamp” LED indicator is lit red and if “Power” indicator flashes red.
- “Temp” LED indicator is lit red and if “Power” indicator flashes red. This indicates the projector has overheated. Under normal conditions, the project can be switched back on.
- “Temp” LED indicator flashes red and if “Power” indicator flashes red.

Unplug the power cord from the projector, wait for 30 seconds and try again. If the warning indicator light up or flash, please contact your nearest service center for assistance.

LED lightning messages

Message	Power LED		Temp LED	Lamp LED
	(Red)	(Blue)	(Red)	(Red)
Standby state (Input power cord)	Steady light			
Power on (Warming)		Flashing (0.5 sec off / 0.5 sec on)		
Power on and Lamp lighting		Steady light		
Power off (Cooling)		Flashing (0.5 sec off / 0.5 sec on). Back to red steady light when cooling fan turns off.		
Quick Resume(100 secs)		Flashing (0.25 sec off / 0.25 sec on)		
Error (Lamp failure)	Flashing			Steady light
Error (Fan failure)	Flashing		Flashing	
Error (Over temp.)	Flashing		Steady light	

- Power off:

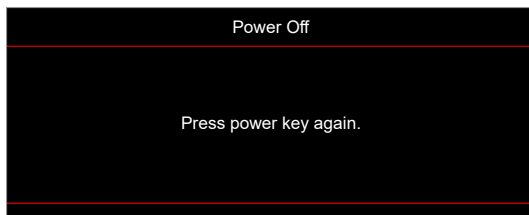

- Temperature warning:

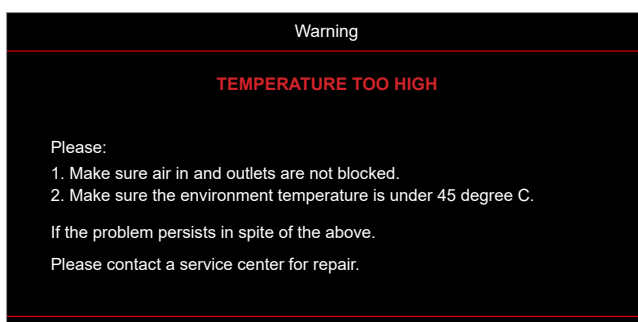

ADDITIONAL INFORMATION

Specifications

Item	Description
Technology	Texas Instrument DMD, 12 degree 0.65"/1080p DMD X1, S600 (Packing typing), Darkchip (DC) 3
Native Resolution	1920x1080
Lens	<ul style="list-style-type: none"> • Throw ratio: 1.4~2.24 • F-stop: 2.5~3.26 • Focal length: 20.911~32.62 mm • Zoom range: 1.6x
Offset	100%~116% ±5%
Image size	20.2"~320.4" (optimized@60")
Projection distance	1m to 10m (optimized@1.87m)
I/Os	<ul style="list-style-type: none"> • HDMI-1 V2.0 (HDCP2.2) • HDMI-2 V1.4 (HDCP1.4) • VGA In • VGA Out • Video • USB Type-A for Power USB 5V/1.5A • Micro USB (for service) • Audio In 3.5mm (x2) • Audio Out 3.5mm • MIC In • 12V Out • 3D SYNC • RS232 • RJ-45 (support web control) • USB Type-A support RK3328 firmware upgrade (USB 2.0 , 5V/0.9A) • USB Type-A support Wi-Fi Dongle for Wireless connection (USB 3.0, 5V/0.9A)
Colour	1073.4 Million color
Scan rate	<ul style="list-style-type: none"> • Horizontal scan rate: 15.375~91.146 KHz • Vertical scan rate: 50~85 Hz (120Hz for 3D feature projector)
Speaker	10W x2
Power consumption	<ul style="list-style-type: none"> • Minimum (ECO mode): <ul style="list-style-type: none"> • 220W (typical), 235W(max)@110VAC • 197W (typical), 227W(max)@220VAC • Maximum (Bright mode): <ul style="list-style-type: none"> • 230W (typical), 292W(max)@110VAC • 245W (typical), 282W(max)@220VAC
Input current	3.2A
Installation orientations	Front, Rear, Ceiling, Rear-top
Dimensions (W x D x H)	<ul style="list-style-type: none"> • Without feet: 337 x 265 x 108 mm (13.27 x 10.43 x 4.25 inches) • With feet: 337 x 265 x 122.5 mm (13.27 x 10.43 x 4.82 inches)
Weight	< 5.0 kg (11.02 lbs)
Environmental	Operating in 0~40°C, 10% to 85% humidity (non-condensing)

Note: All specifications are subject to change without notice.



ADDITIONAL INFORMATION

Optoma global offices

For service or support, please contact your local office.



USA

47697 Westinghouse Drive,
Fremont, CA 94539, USA
www.optomausa.com

 888-289-6786
 510-897-8601
 services@optoma.com



Canada

47697 Westinghouse Drive,
Fremont, CA 94539, USA
www.optomausa.com

 888-289-6786
 510-897-8601
 services@optoma.com

Latin America

47697 Westinghouse Drive,
Fremont, CA 94539, USA
www.optomausa.com

 888-289-6786
 510-897-8601
 services@optoma.com



Europe

Unit 1, Network 41, Bourne End Mills,
Hemel Hempstead, Herts,
HP1 2UJ, United Kingdom
www.optoma.eu
Service Tel : +44 (0)1923 691865

 +44 (0) 1923 691 800
 +44 (0) 1923 691 888
 service@tsc-europe.com



Benelux BV

Randstad 22-123
1316 BW Almere
The Netherlands
www.optoma.nl

 +31 (0) 36 820 0252
 +31 (0) 36 548 9052



France

Bâtiment E
81-83 avenue Edouard Vaillant
92100 Boulogne Billancourt, France

 +33 1 41 46 12 20
 +33 1 41 46 94 35
 savoptoma@optoma.fr



Spain

C/ José Hierro,36 Of. 1C
28522 Rivas VaciaMadrid,
Spain

 +34 91 499 06 06
 +34 91 670 08 32



Deutschland

Am Nordpark 3
41069 Mönchengladbach
Germany

 +49 (0) 2161 68643 0
 +49 (0) 2161 68643 99
 info@optoma.de

Scandinavia

Lerpeveien 25
3040 Drammen
Norway

 +47 32 98 89 90
 +47 32 98 89 99
 info@optoma.no

PO.BOX 9515
3038 Drammen
Norway

Korea

<https://www.optoma.com/kr/>

Japan



<https://www.optoma.com/jp/>

Taiwan

<https://www.optoma.com/tw/>

China

5F, No. 1205, Kaixuan Rd.,
Changning District
Shanghai, 200052, China

 +86-21-62947376
 +86-21-62947375
www.optoma.com.cn

Australia

<https://www.optoma.com/au/>

